

# Expansion clamp

익스펜션클램프 실시예

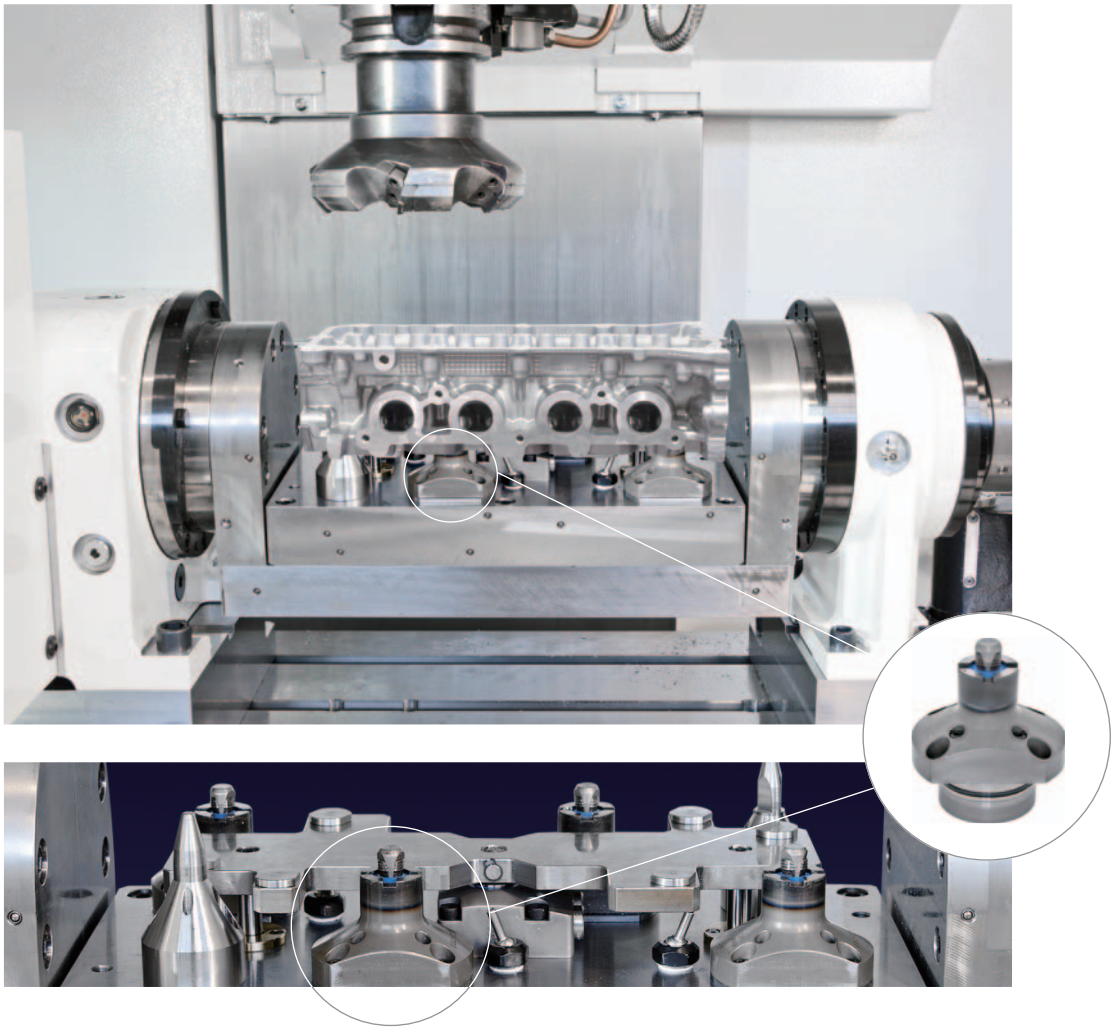

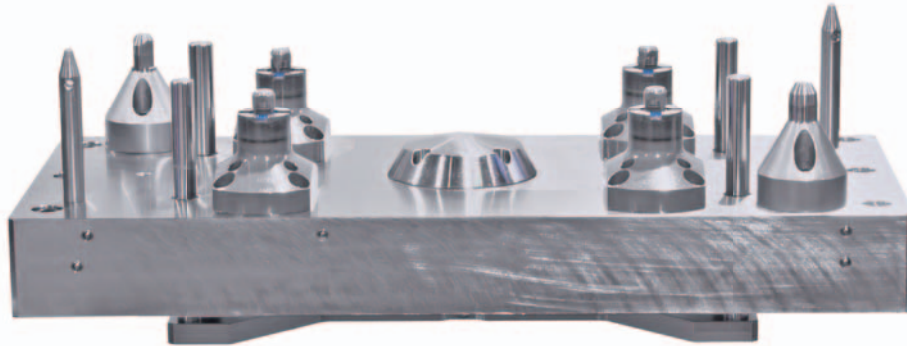

치구

CGC-N22E11 × 4개

클램프홀경:  $\phi 11$

클램프력: 12.0 kN

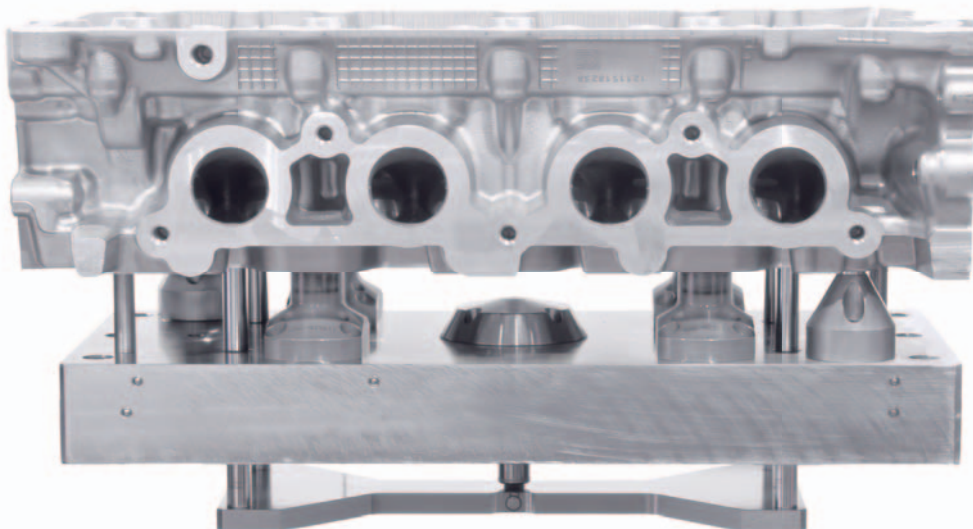

실린더헤드

알루미늄다이캐스트

425 × 210 × 110 mm

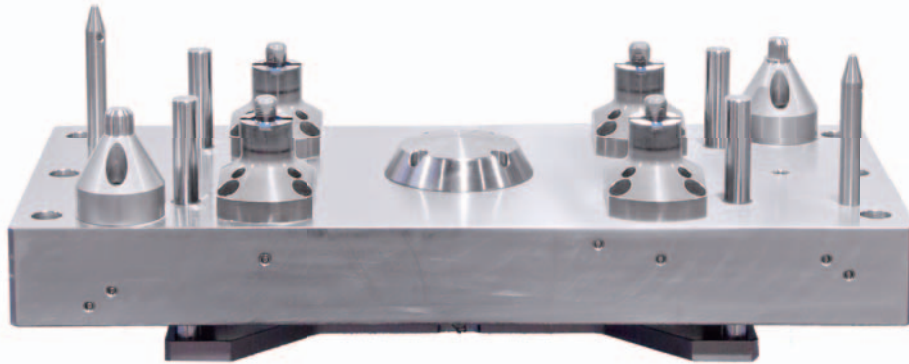

치구

CGC-N22E11 × 4개

클램프홀경:  $\phi 11$

클램프력: 12.0 kN

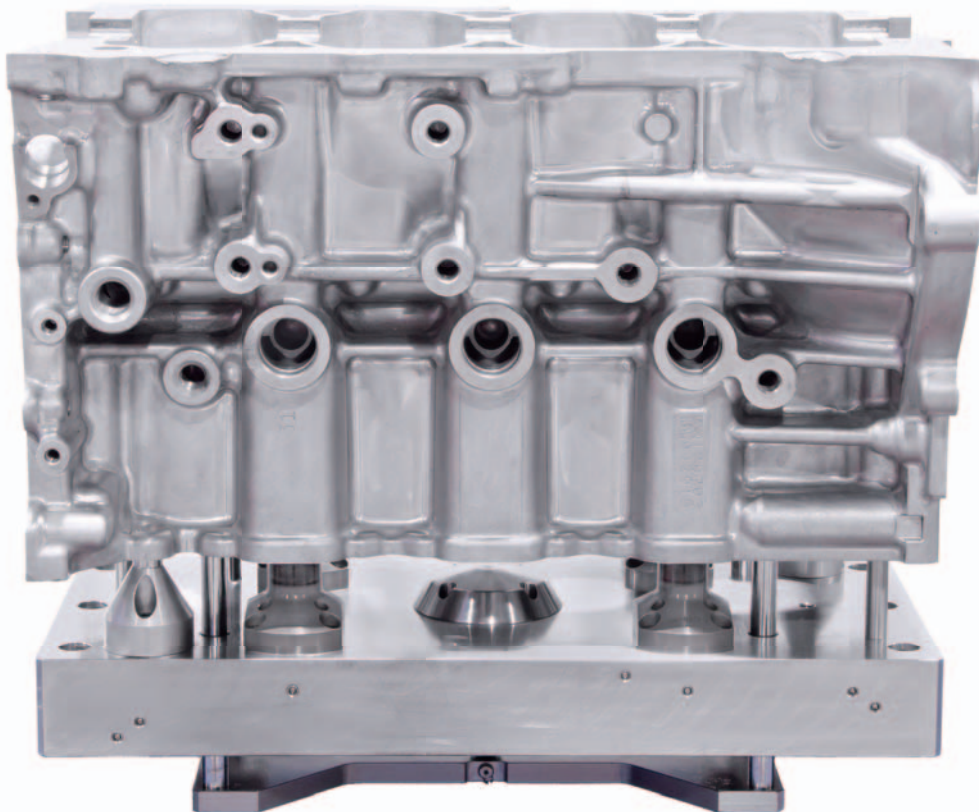

실린더블록

알루미늄다이캐스트

400 × 210 × 240 mm

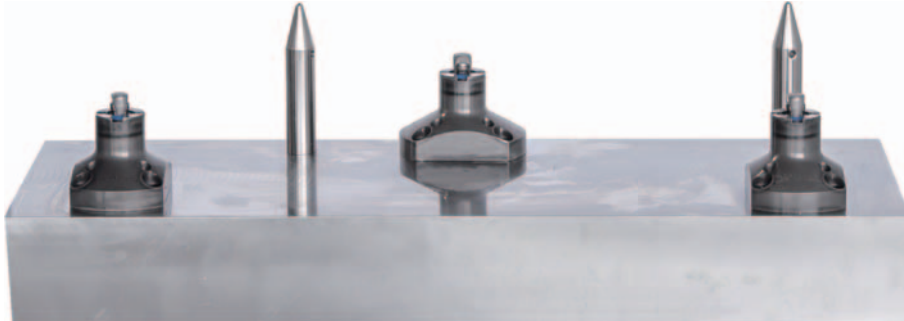

치 구

CGC-N22E10×3개

클램프홀경:ø10

클램프력:9kN

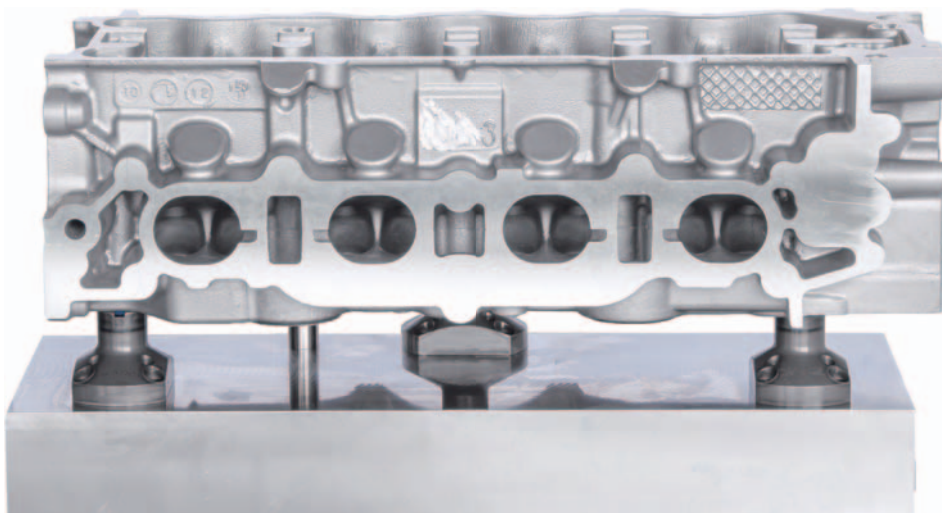

실린더헤드

알루미늄다이캐스트

410×220×120 mm





치구

CGC-N22E12×4개

클램프홀경:ø12

클램프력:12kN

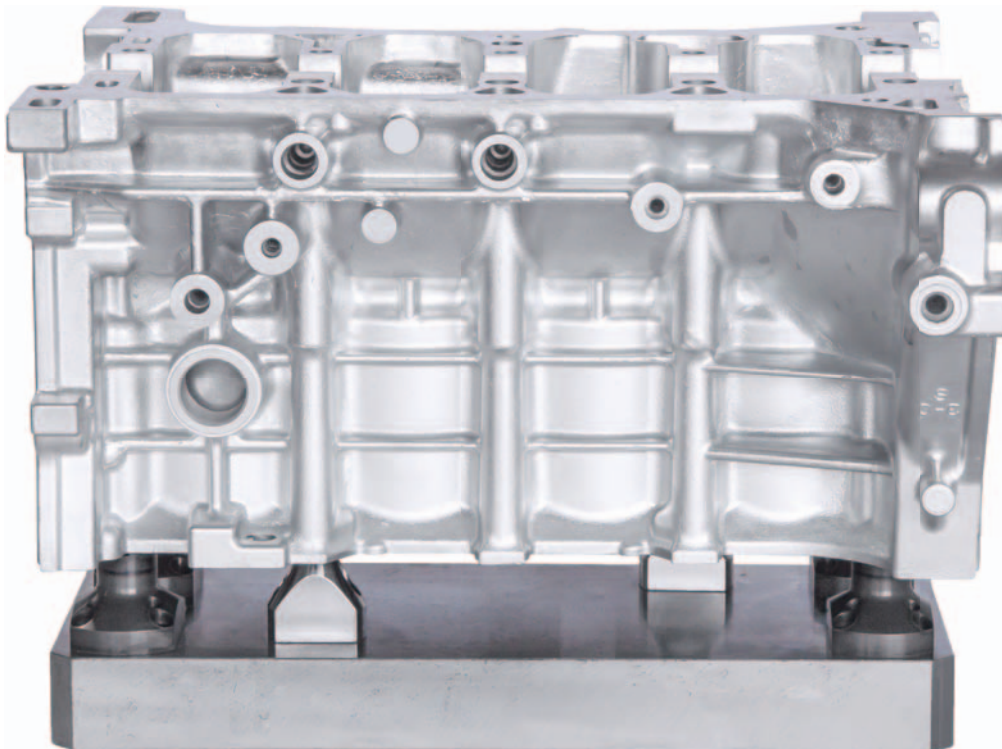

실린더블록

알루미늄다이캐스트

395×377×203 mm

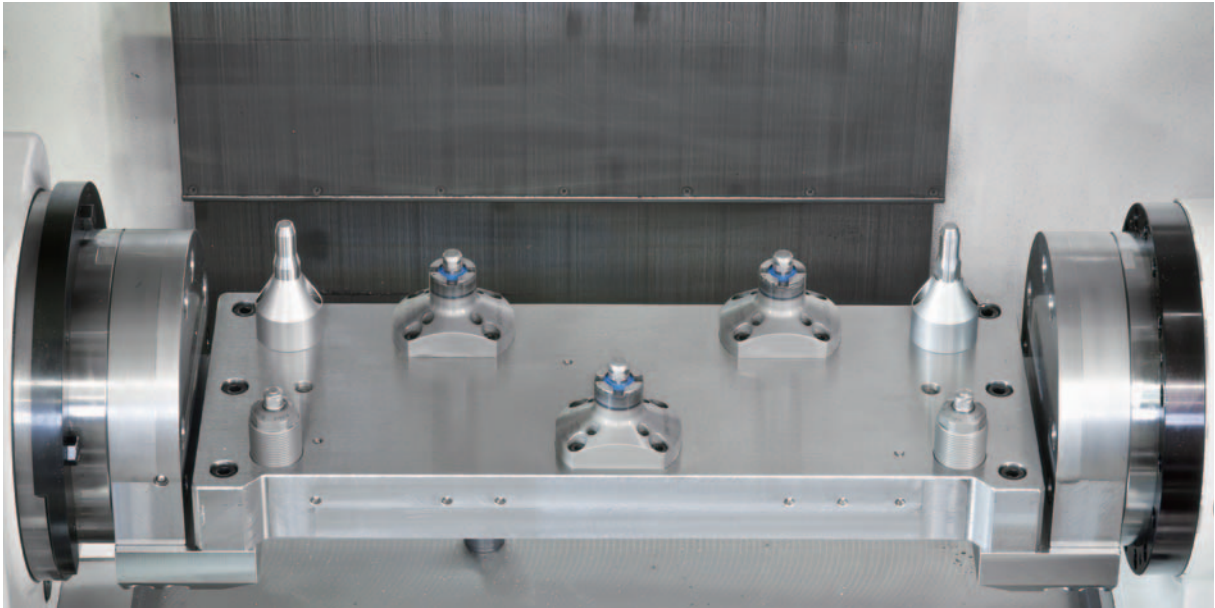

실린더헤드 가공 치구

CGC-N22E11×3개 CSN00LB×2개

클램프홀경:ø11

클램프력:9.0kN 워크파지력:4kN

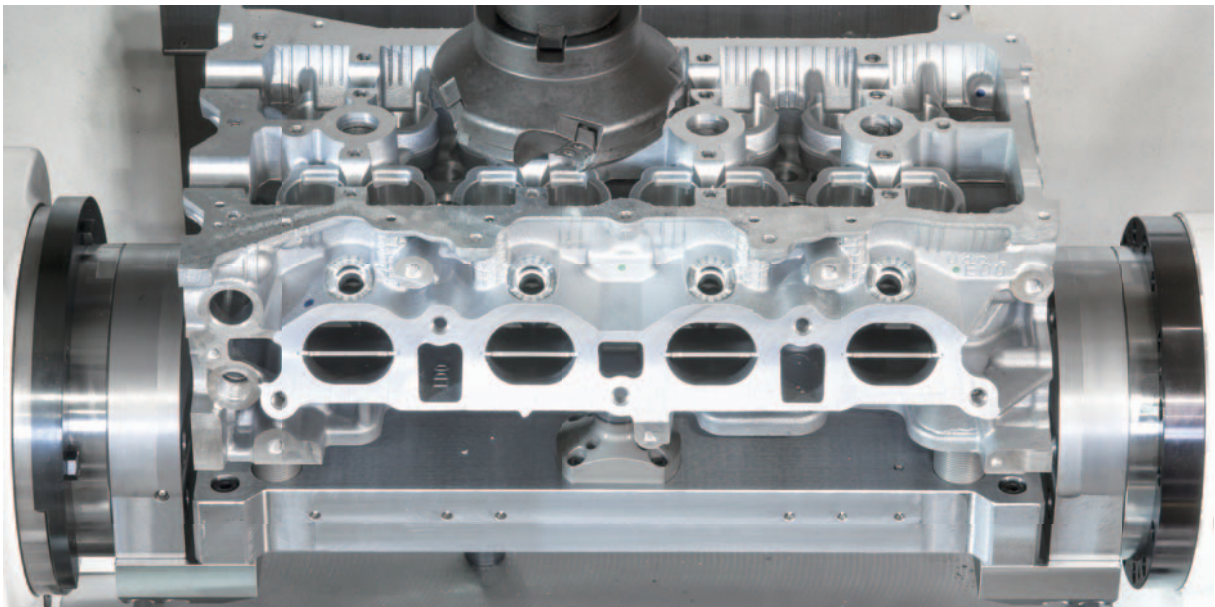

실린더헤드

알루미늄다이캐스트

414×193×125 mm



가공치구

CGC-N22E09×3개

클램프홀경:ø9

클램프력:9.0kN

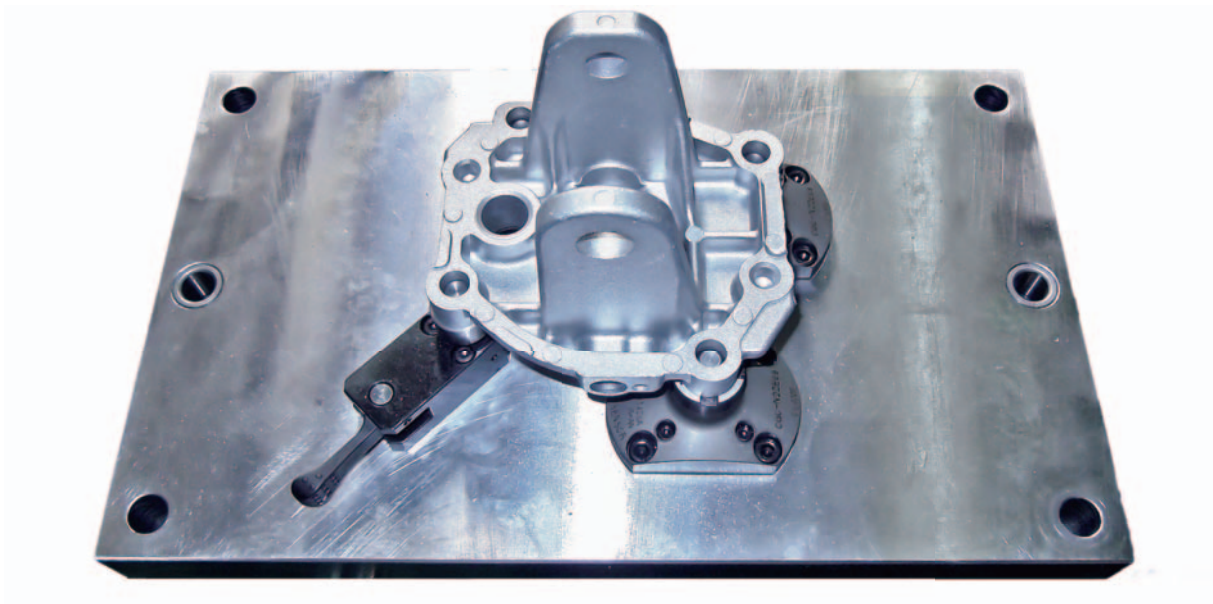

워크

알루미늄다이캐스트

150×150×150 mm



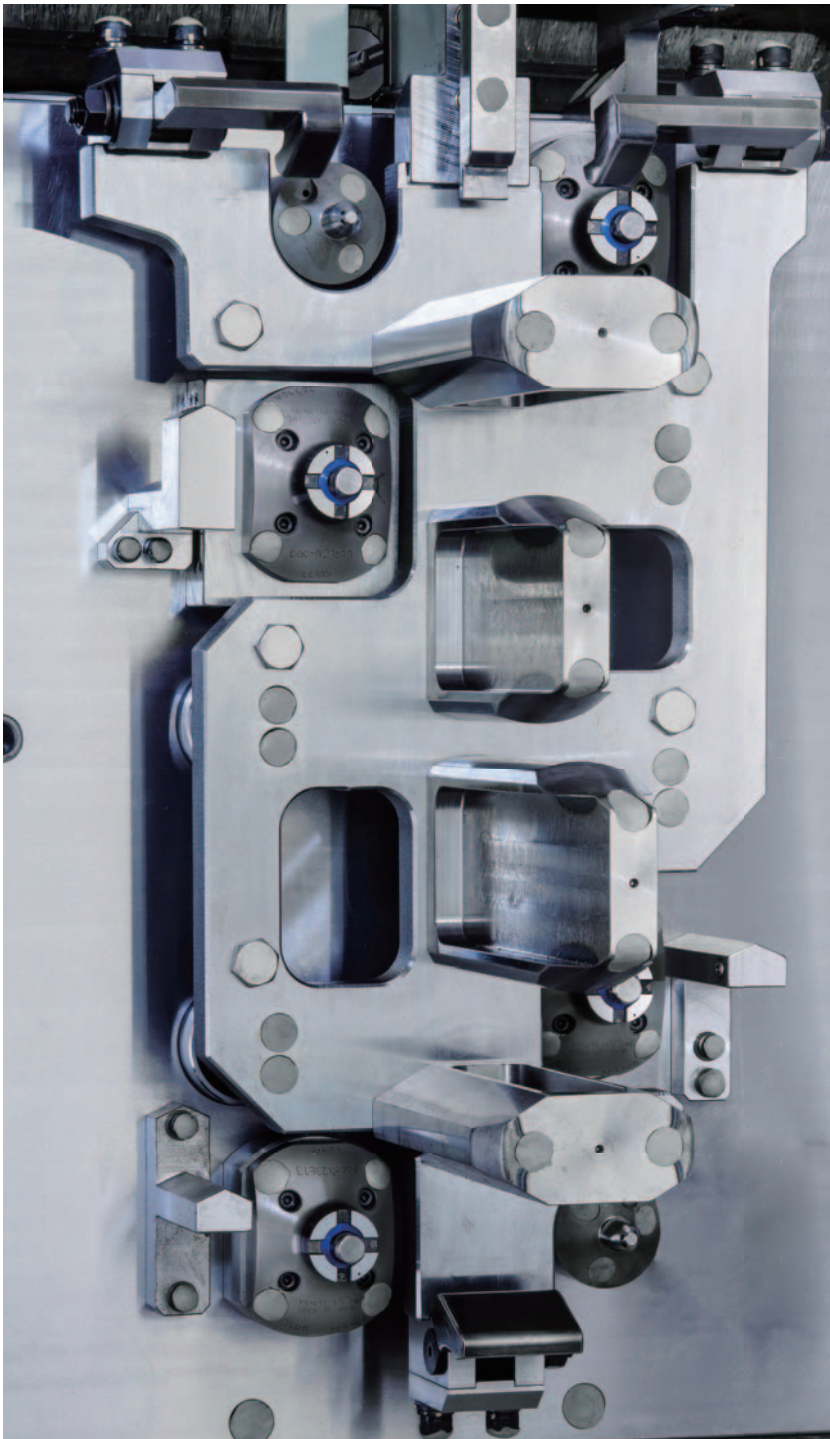

실린더블록 가공 치구

CGC-N23E13×4개

클램프홀경:ø13

클램프력:30.0kN

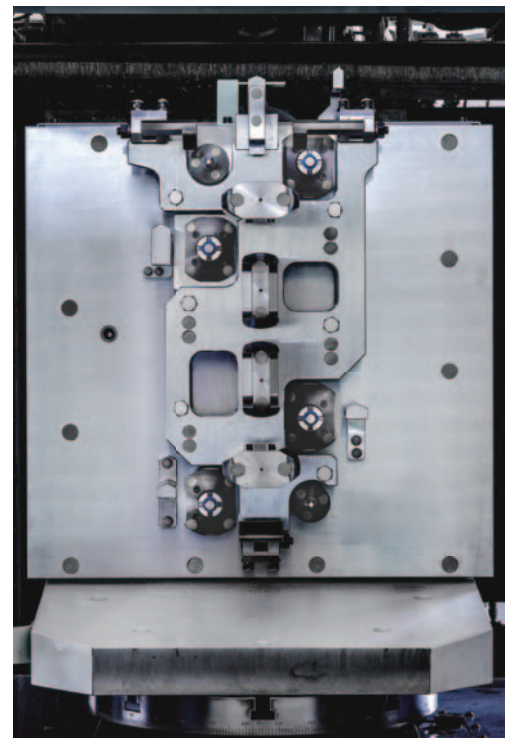

실린더블록

알루미늄다이캐스트

414×193×125 mm



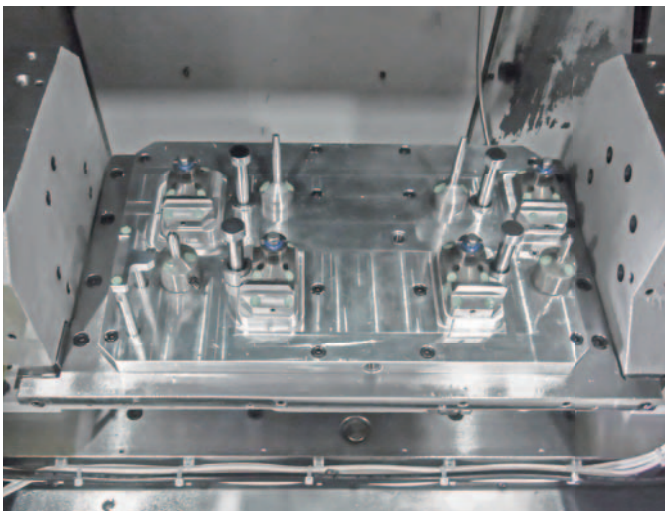
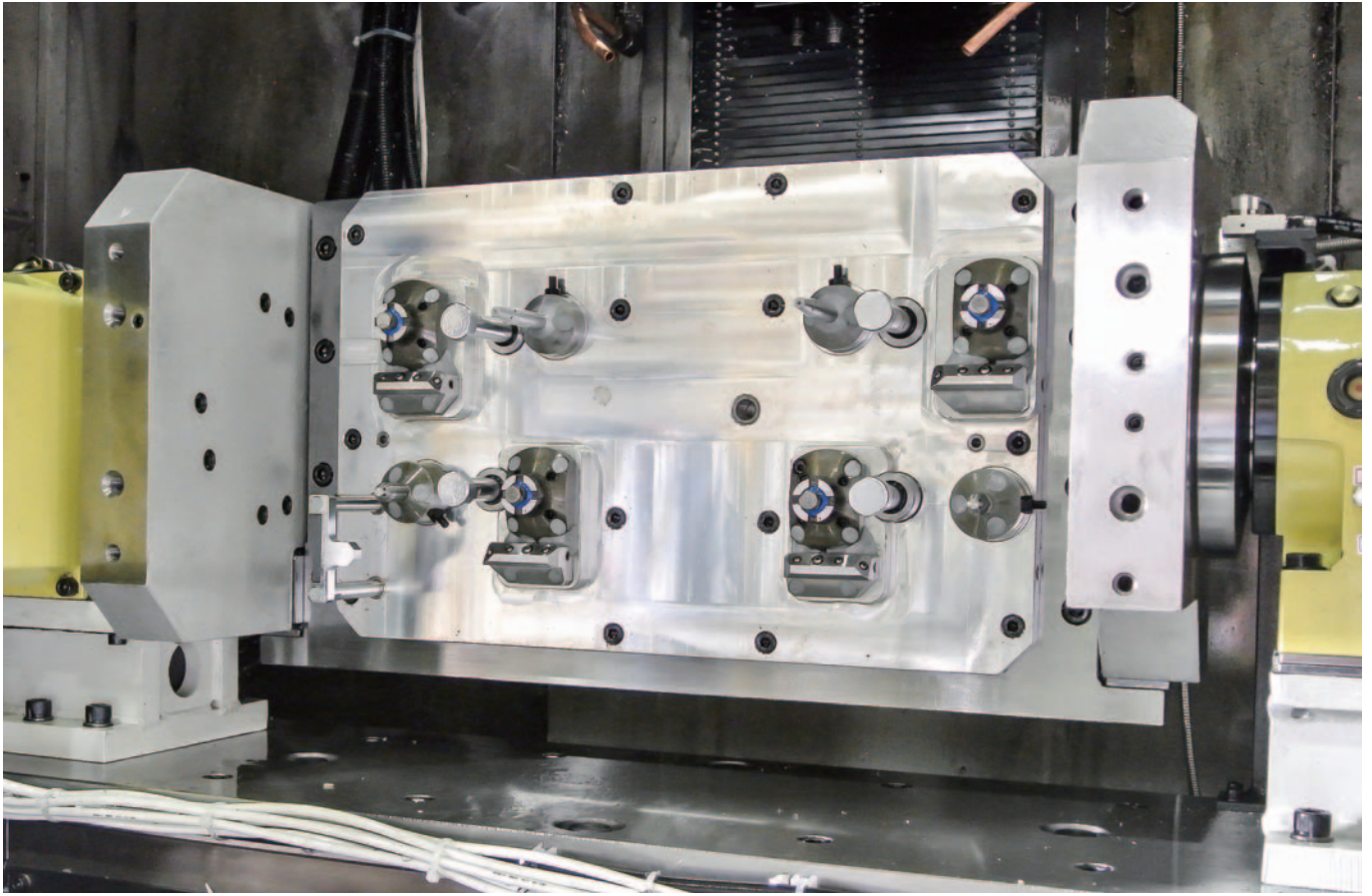

실린더헤드 가공치구

CGC-N22E13×4개

클램프홀경:ø13

클램프력:10.0kN

실린더헤드

알루미늄다이캐스트

425×220×110 mm

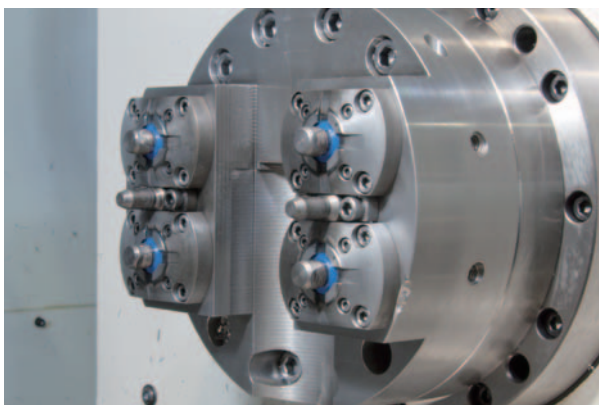
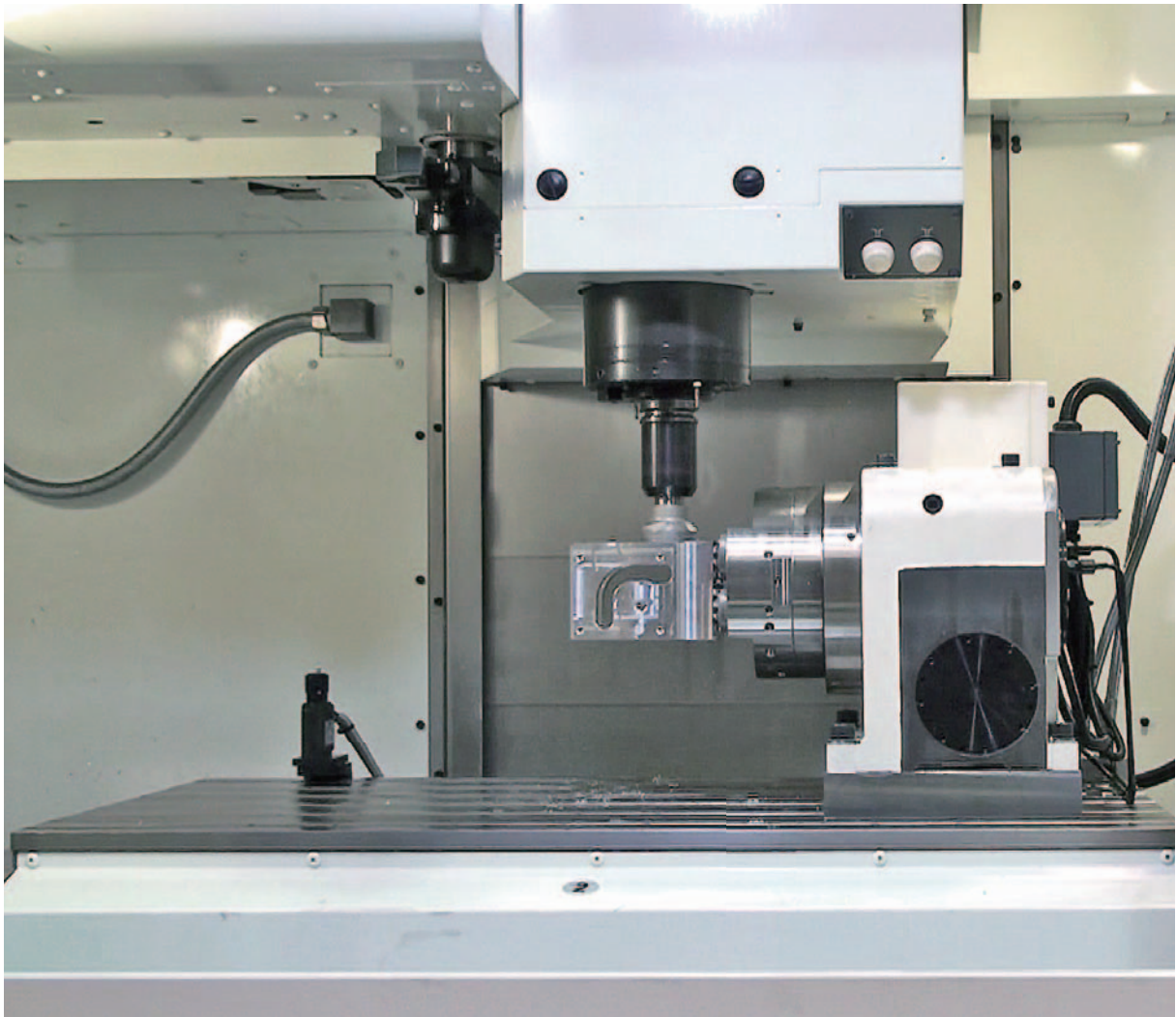

치구

CGS-N22E12×4개

클램프홀경:ø12

클램프력:14 kN

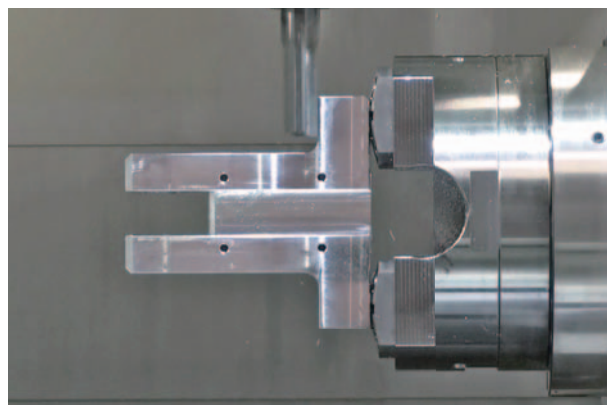

워크

A2017 (두랄루민)

200×100×150 mm



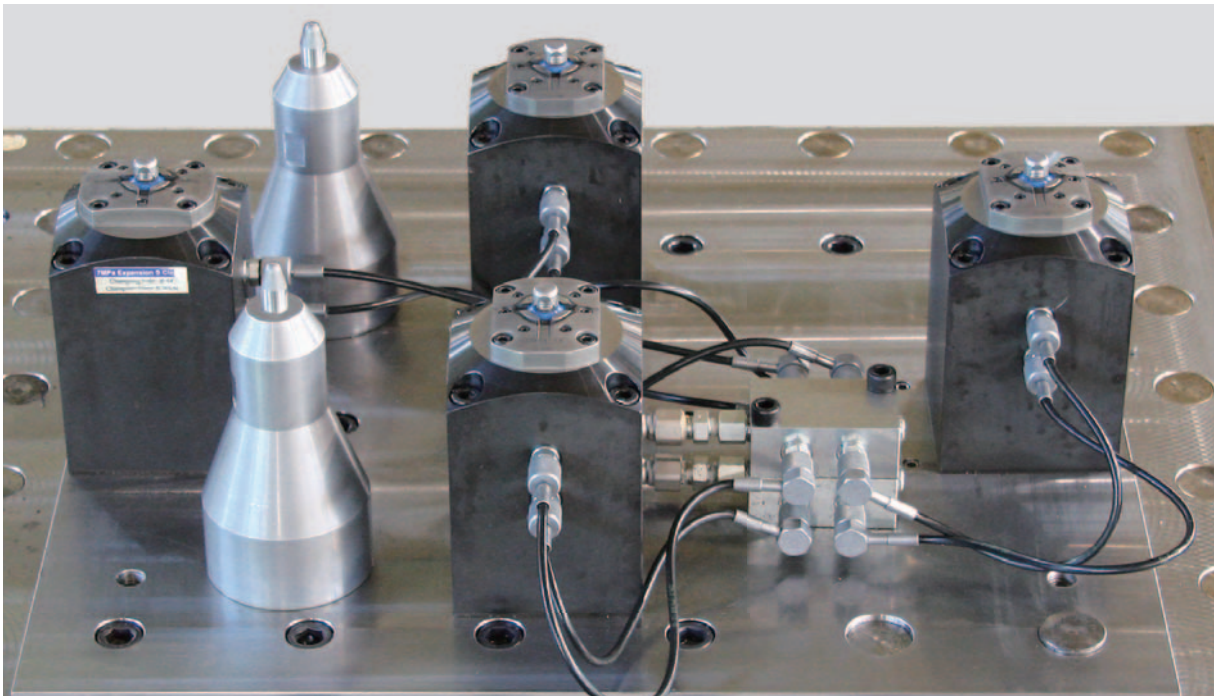

치구

CGS-N23E14×4개

클램프홀경:ø14

클램프력:29.6 kN

위크

S45C

578×450×60 mm

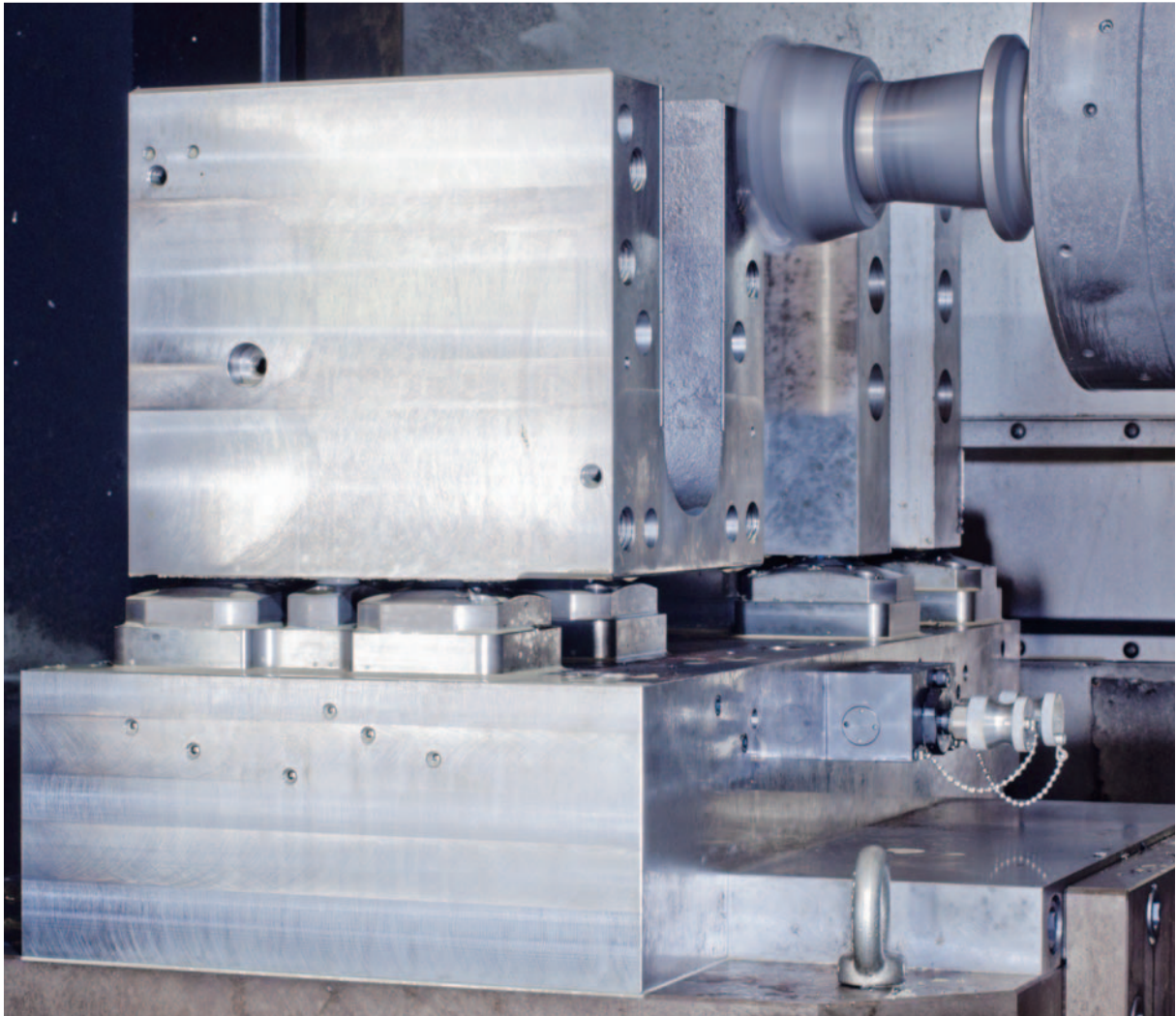

치구

CGS-N24E17×4개

클램프홀경:φ17

클램프력:54 kN



워크

FCD400

200×200×200 mm



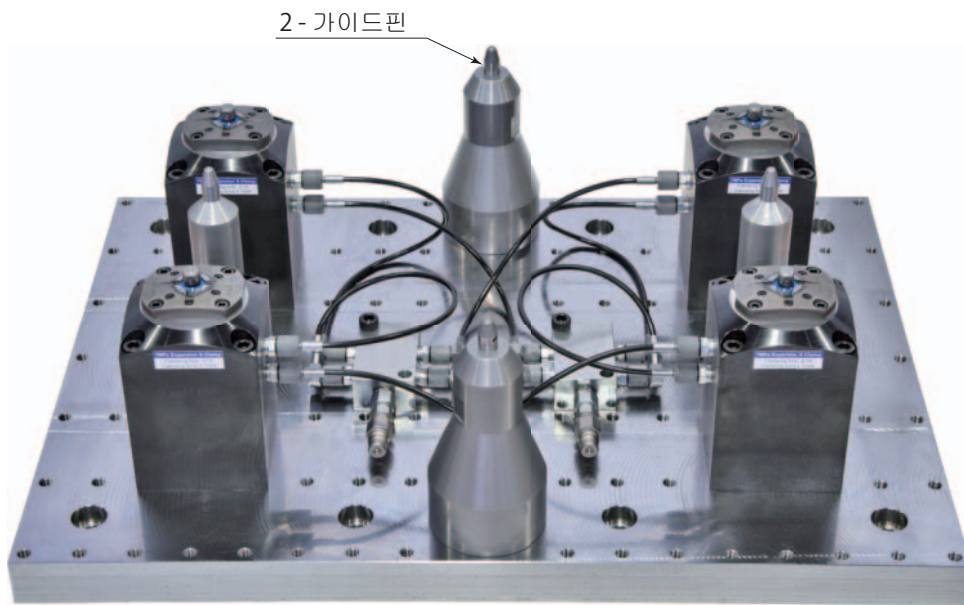

치구

CGS-N23E14×4개

클램프홀경:ø14

클램프력:29.6 kN

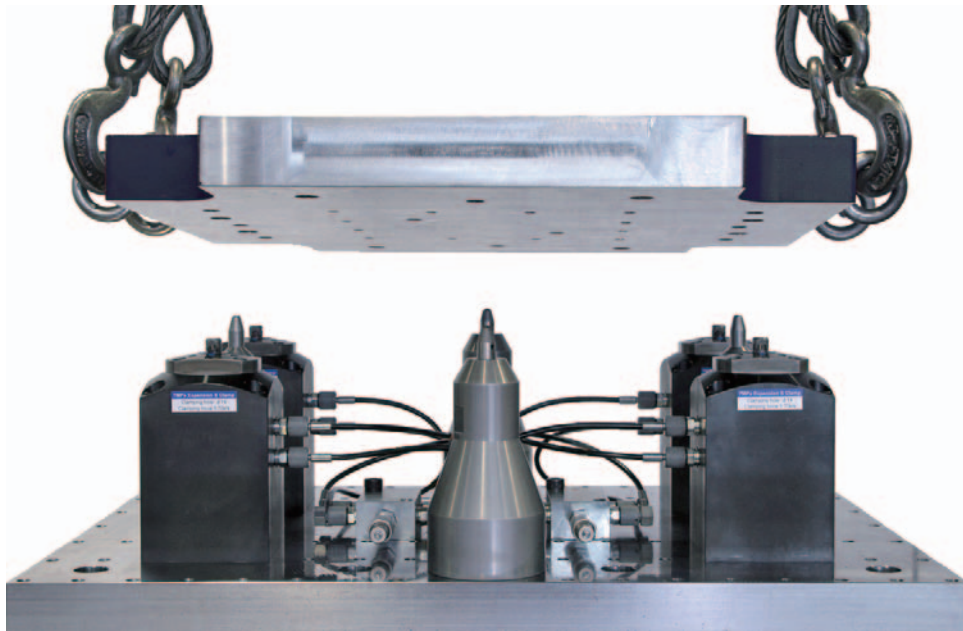

위크

SS400

570×570×50 mm

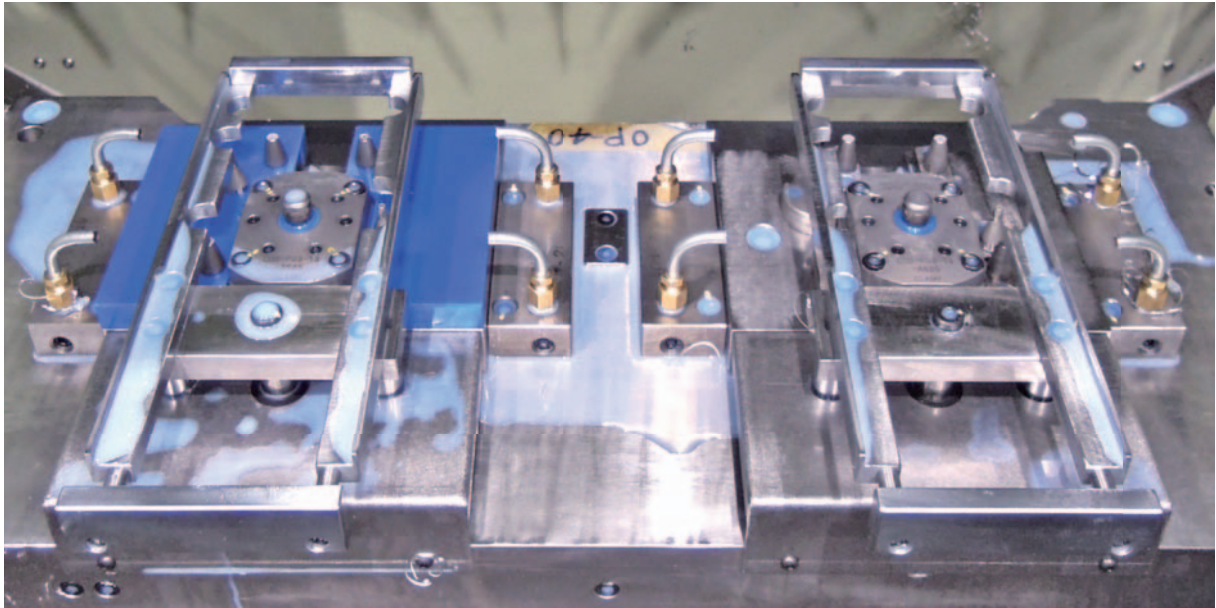

치구

CGS-P23-14×1개

클램프홀경:ø14

클램프력:5.3 kN

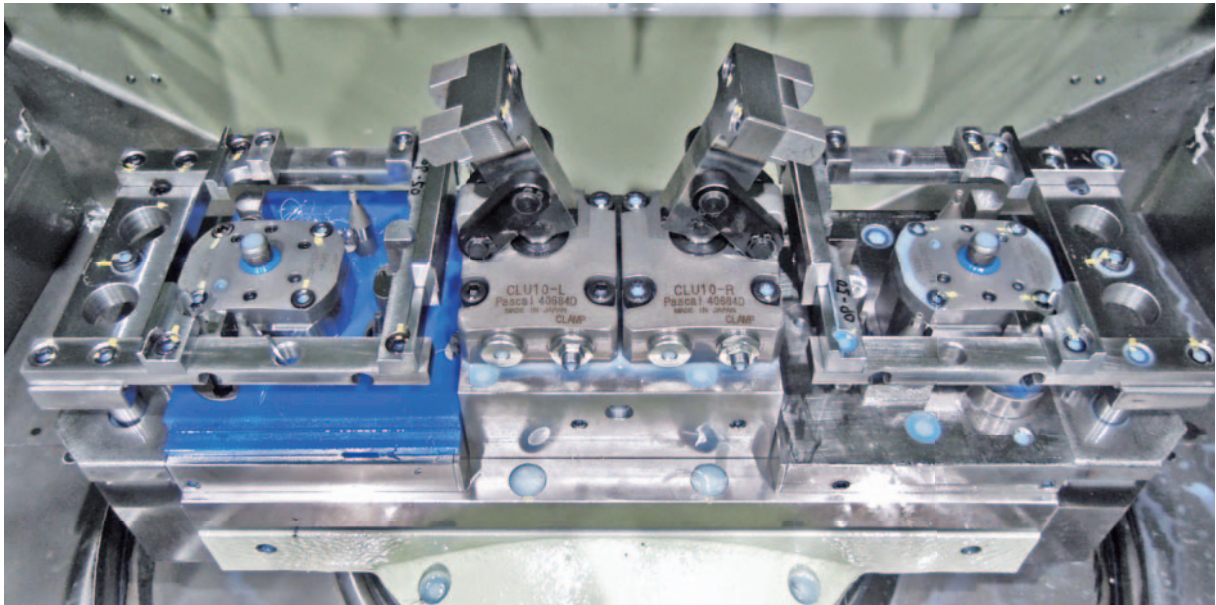

치구

CGS-P23-14×1개 CLU10-L/R×1개

클램프홀경:ø14

클램프력:10.4 kN





치구

CGS-N22-09×3개

클램프홀경:ø9

클램프력:6 kN

매니폴드스페이서

AC4BF(알루미늄다이캐스트)

200×70×15 mm

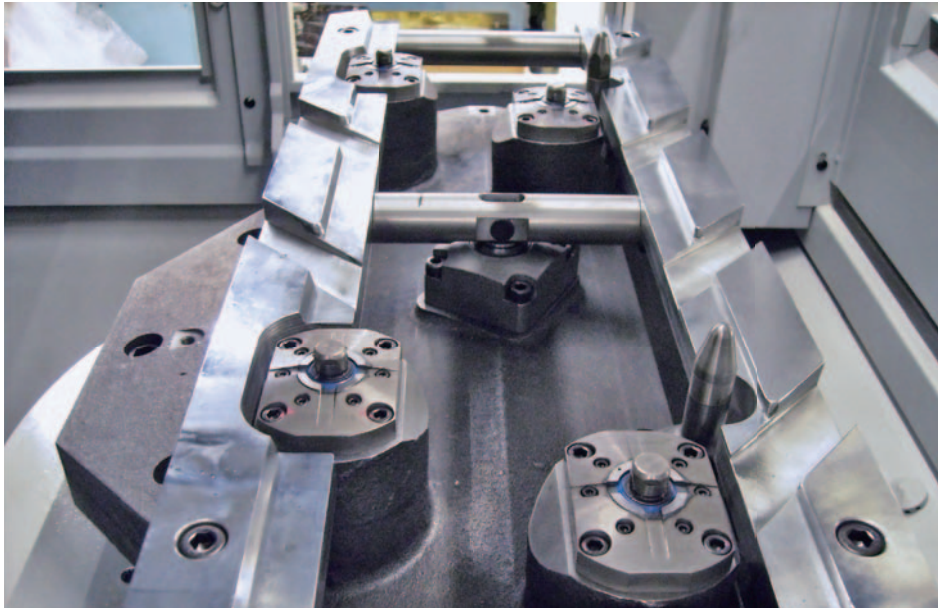

치구

CGS-N23-15×4개

클램프홀경:ø15

클램프력:19.6 kN

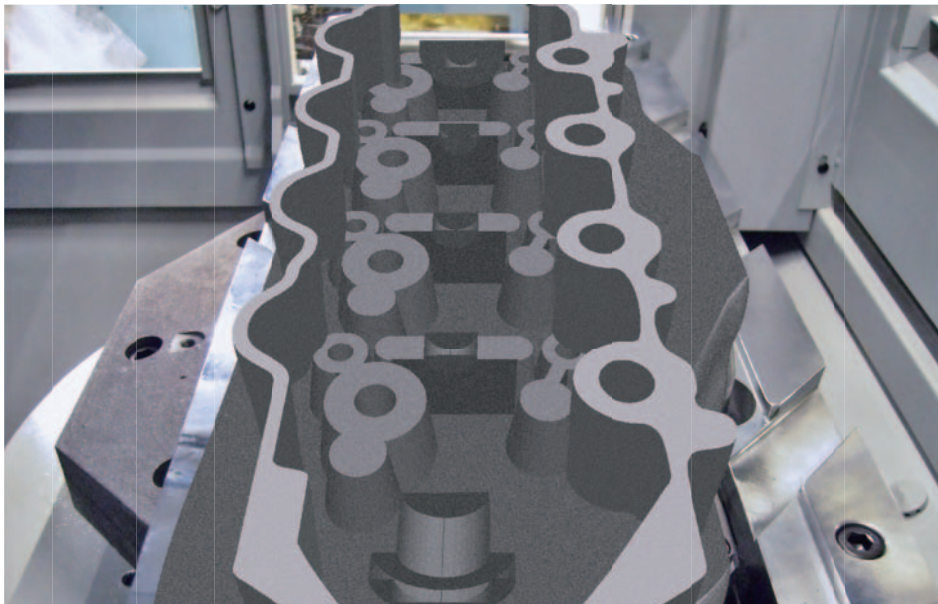

실린더헤드

FCD250(주철)

500×220×120 mm



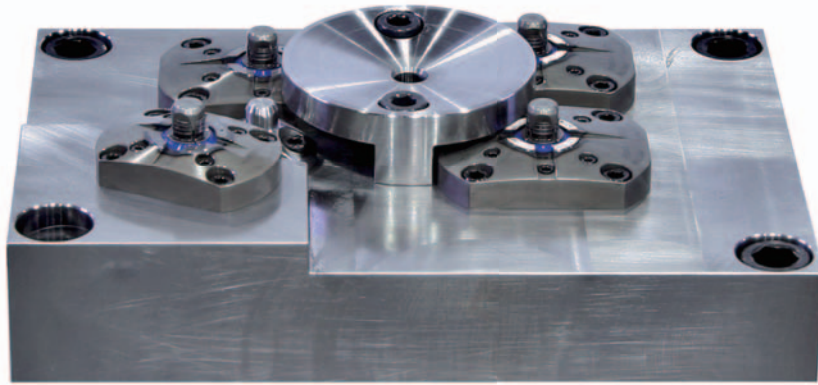

치구

CGS-N23-12×3개 CGS-N22-12×1개

클램프홀경:ø12

클램프력:19.6 kN

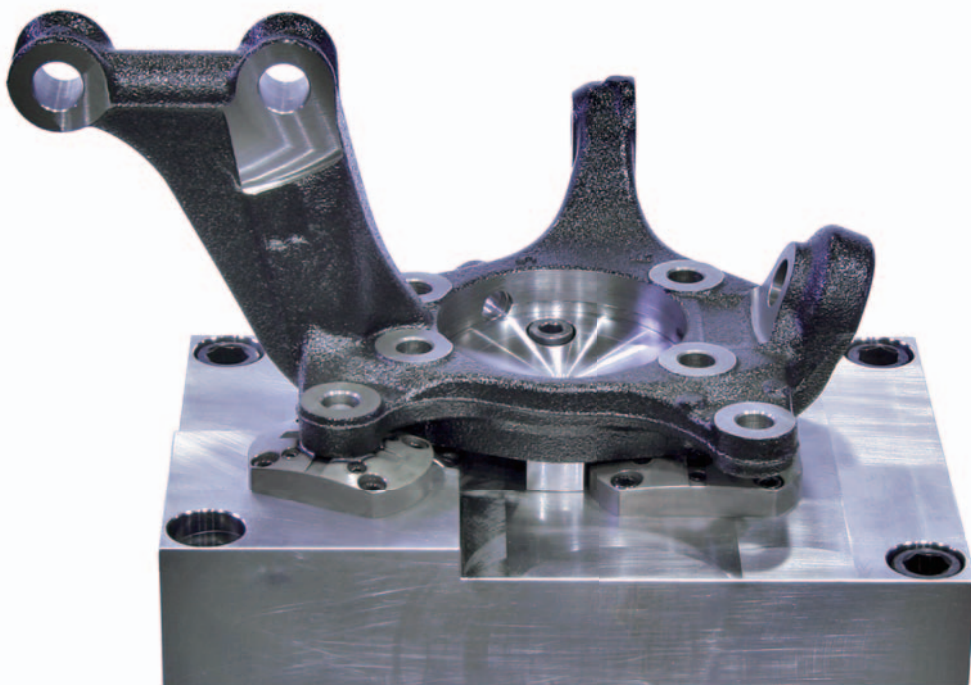

스티어링너클

FCD400(주철)

300×230×130 mm

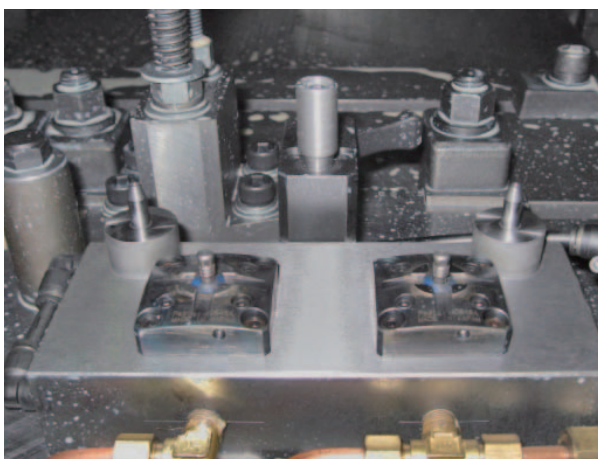
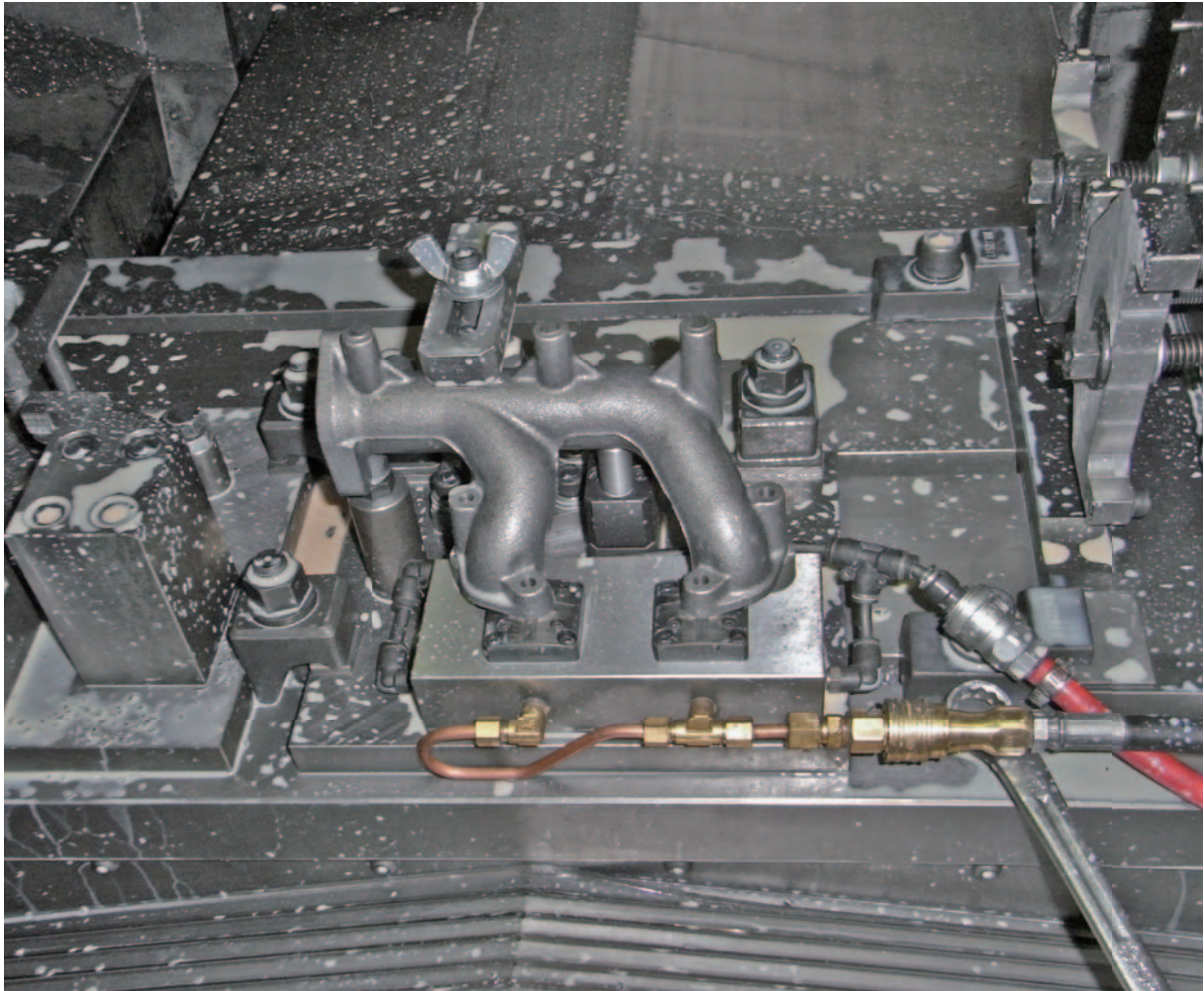

치구

CGS-N11-06×2개

클램프홀경:ø6

클램프력:0.9 kN

이그저스트매니폴드

FC250 (주철)

300×250×150 mm



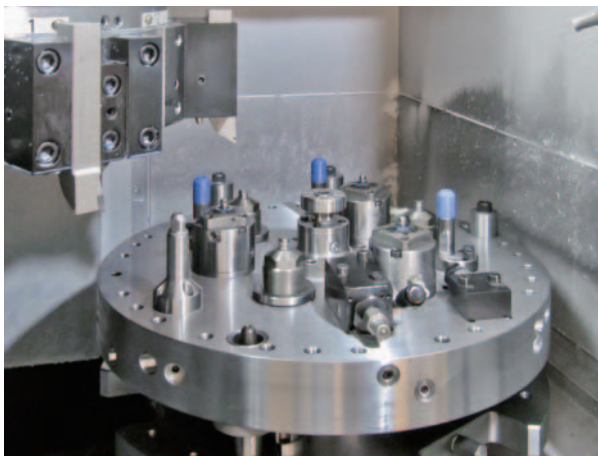

수직선반 치구

CGS-N12E09×3개

클램프홀경:ø9

클램프력: 3.5 kN



리테이너 가공 치구

CGT-F22-11×3개

클램프홀경:ø11

클램프력:7.5 kN

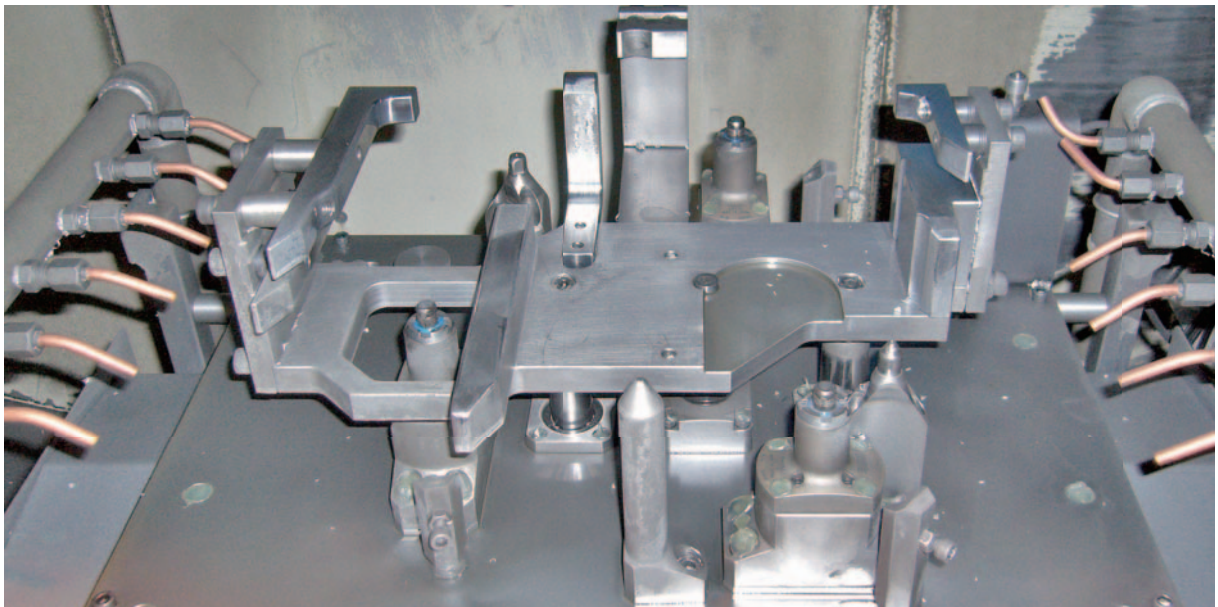

미션케이스 가공 치구

CGT-F22-11×3개

클램프홀경:ø11

클램프력:7.5 kN



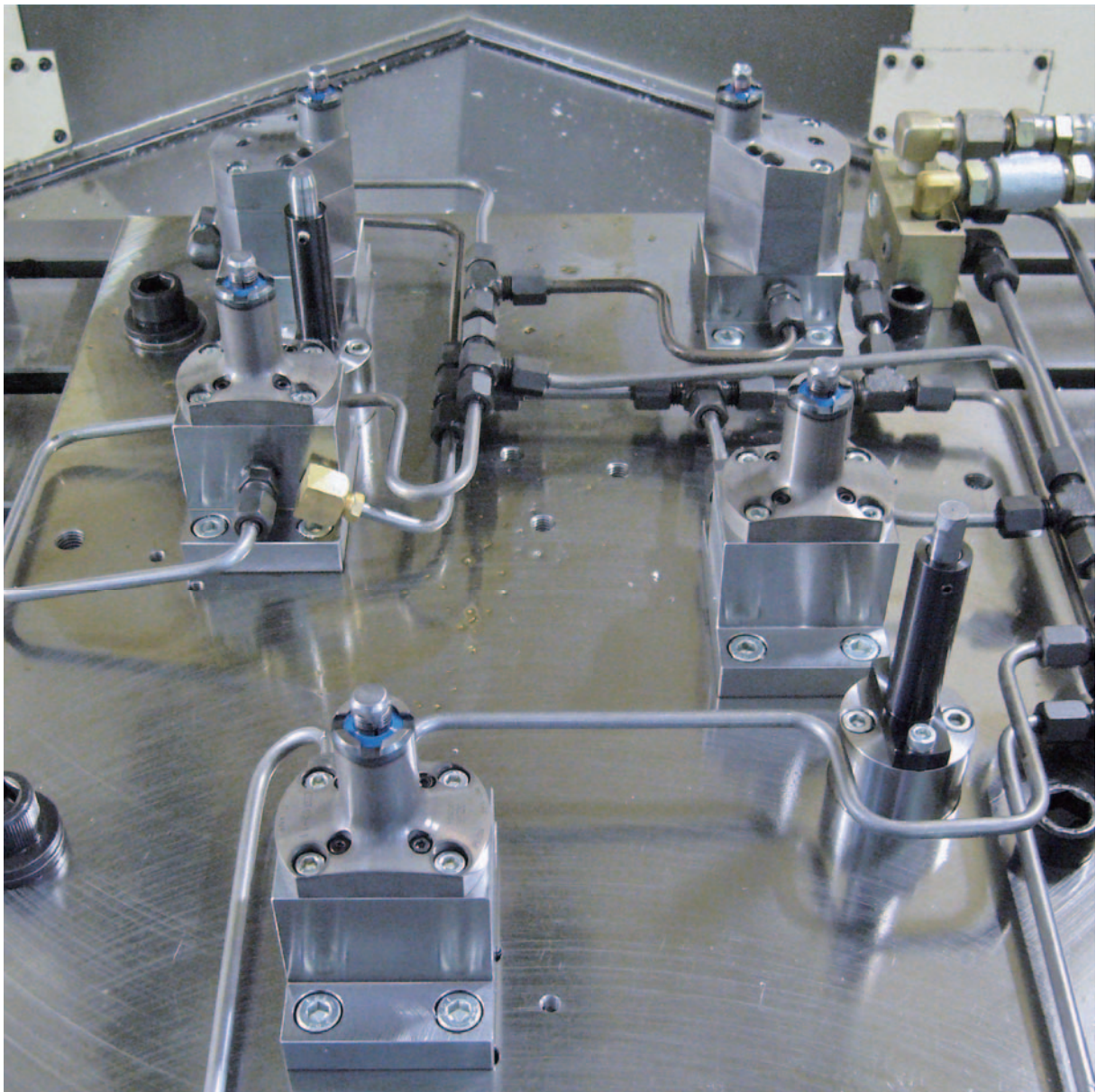

미션 케이스 가공 치구

CGT-F22-11×3개 CGU-F22-09×2개

클램프홀경:ø11,ø9

클램프력:6.6 kN

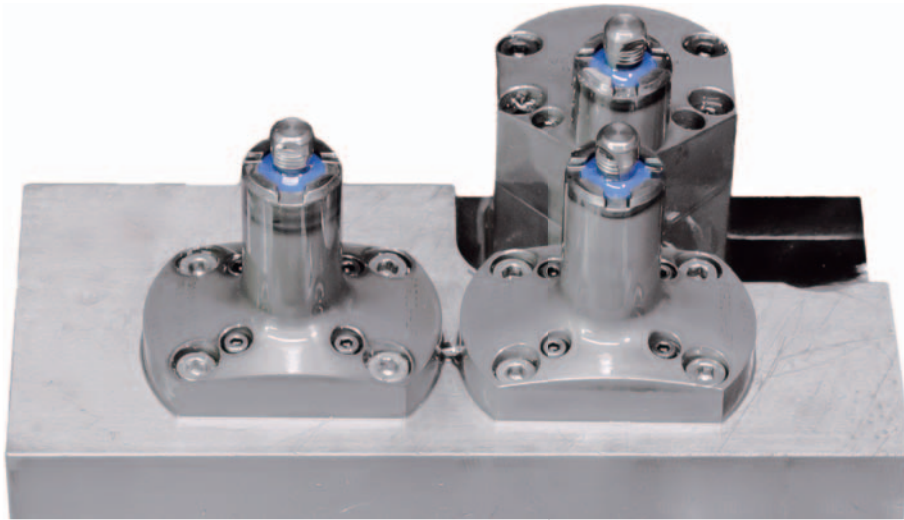

스테인리스부품 가공치구

CGT-F22E09×2개 CGU-F22E09×1개

클램프홀경:ø9

클램프력:9.8kN

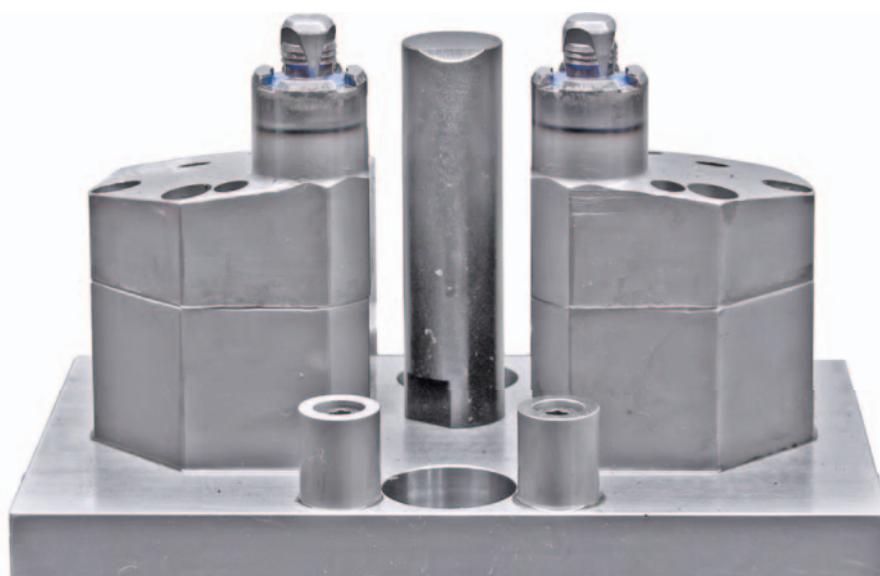

스테인리스부품 가공치구

CGU-F22E11×2개

클램프홀경:ø10.7

클램프력:5.5kN



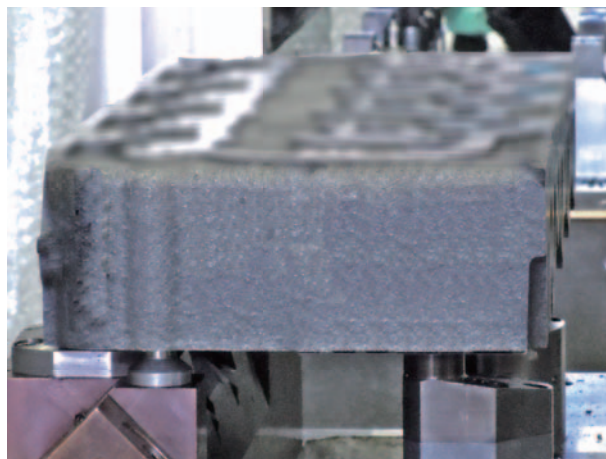
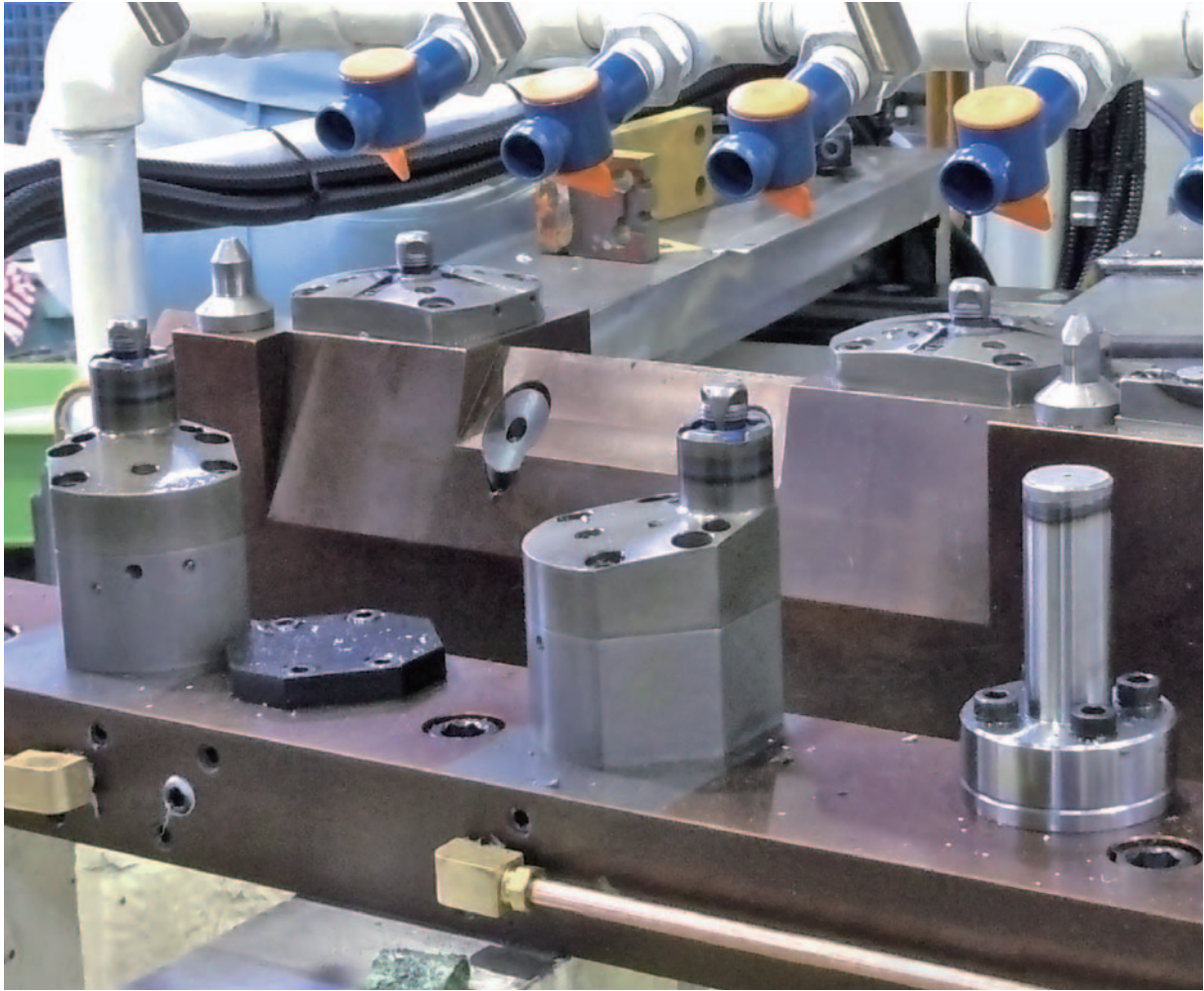

치구

CGU-F22E12×2개 CGS-N23E12 x 2개

클램프홀경:  $\phi 12$

클램프력: 13.6 kN

실린더헤드

FC250

432 × 183 × 70 mm

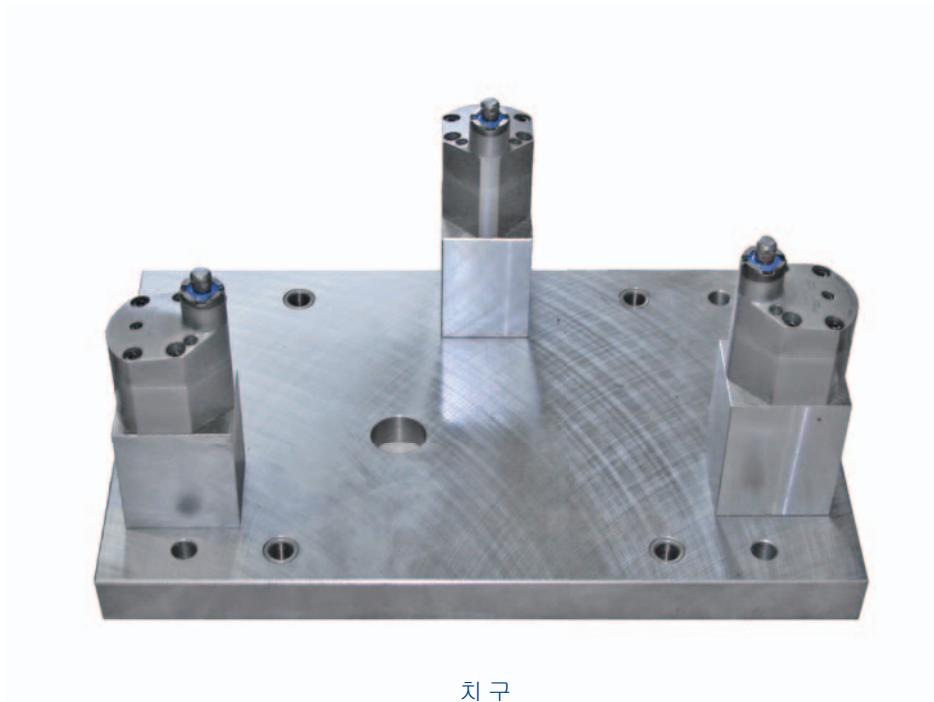

치구

CGU-F22-11×3개

클램프홀경:ø11

클램프력:3.5 kN

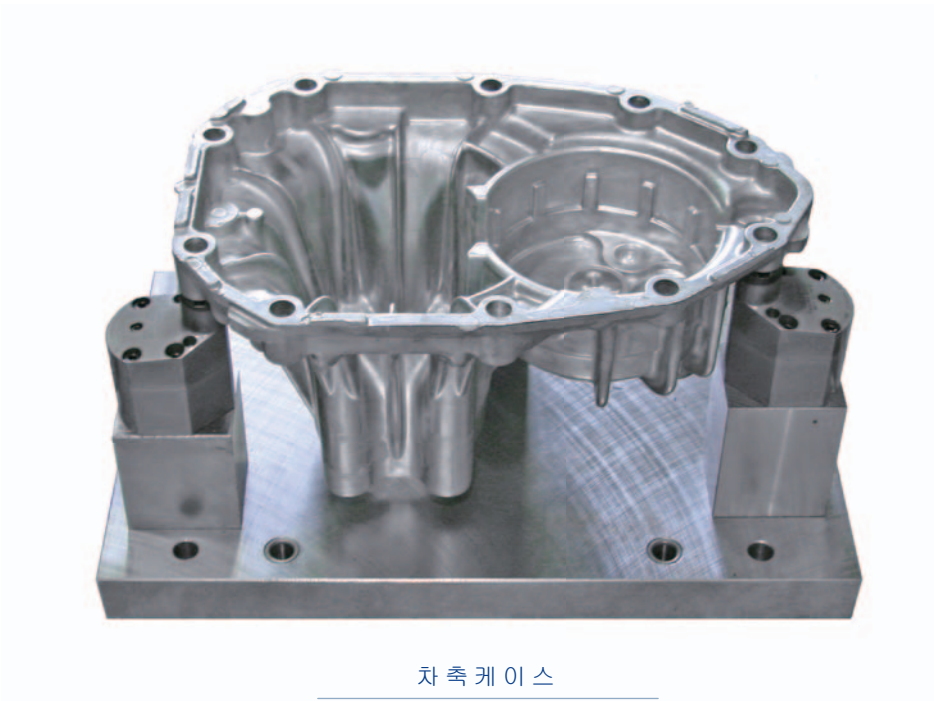

차축케이스

알루미늄다이캐스트

210×270×160 mm



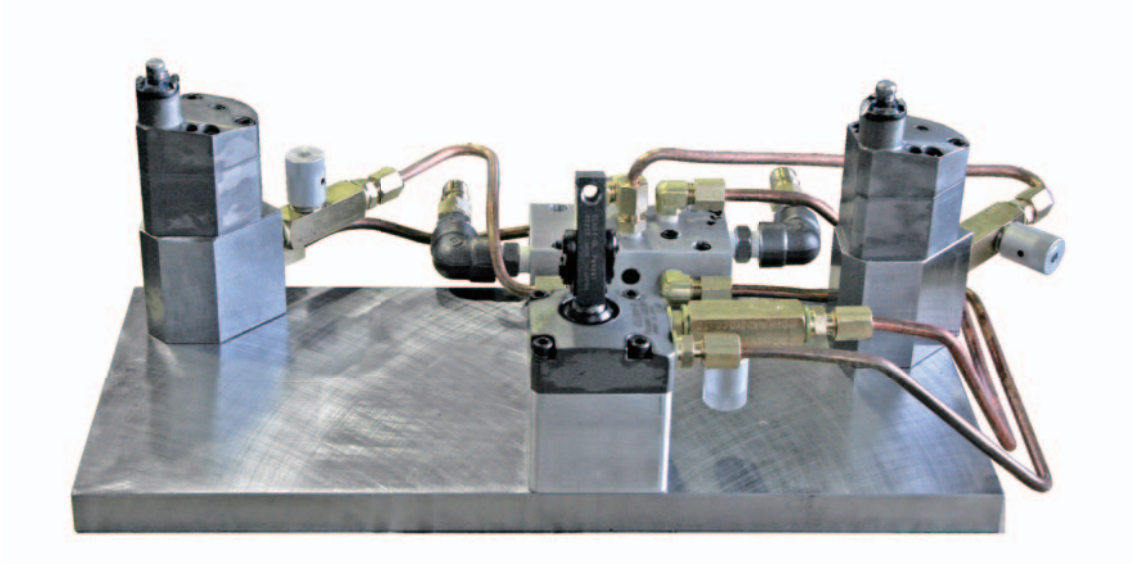

치구

CGU-F22-09×2개 CLU04-R×1개

클램프홀경:ø9

클램프력:1.6 kN

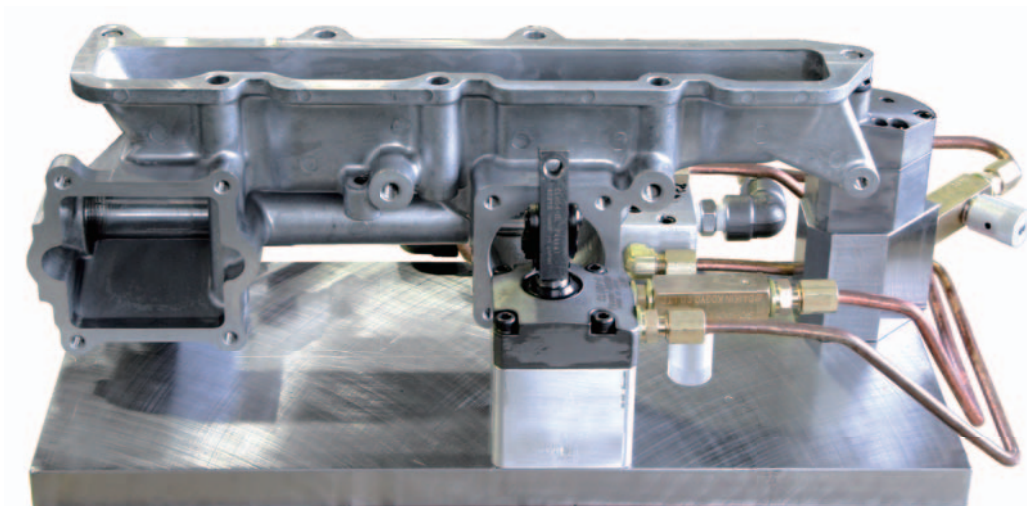

인렛매니폴드

알루미늄다이캐스트

370×100×125 mm



가공치구

CGE-N22E070×2개

클램프홀경:ø7

클램프력:1.3 kN

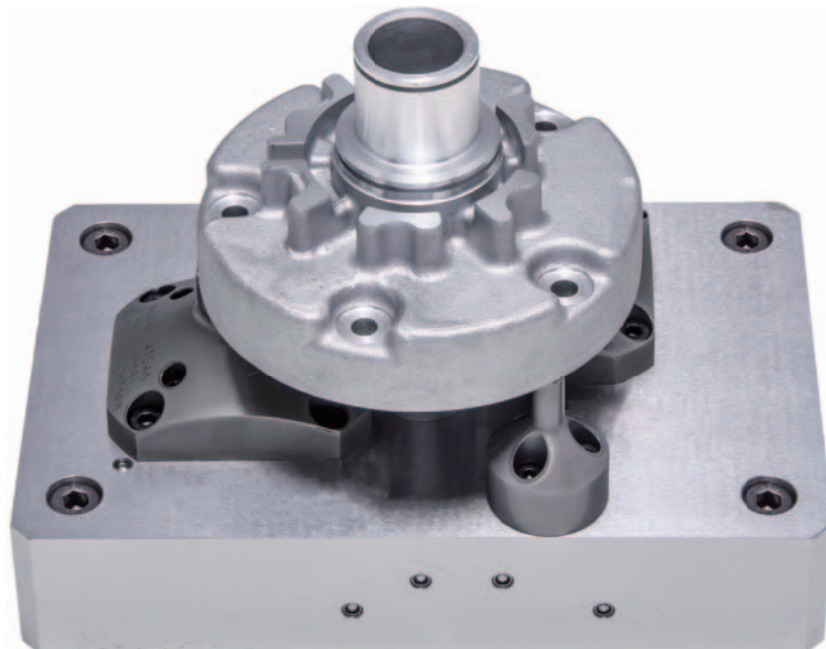

컴프레서부품

알루미늄다이캐스트

ø110×67 mm





가공 치구

CGE-N22E085×1개 CGE-N22E076×1개

클램프홀경:ø8.5 ø7.6

클램프력:1.3 kN

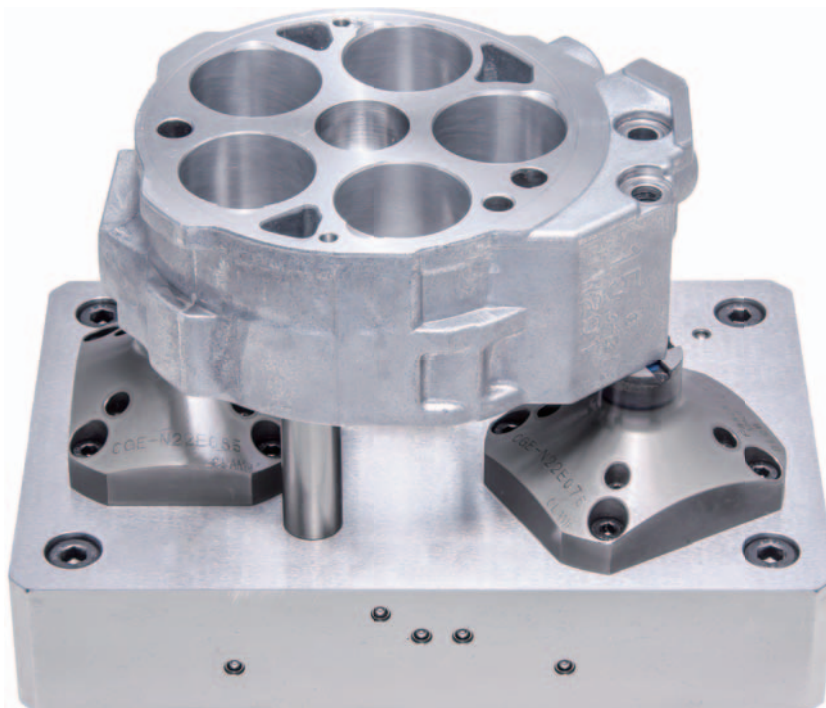

컴프레서부품

알루미늄다이캐스트

145×120×50 mm

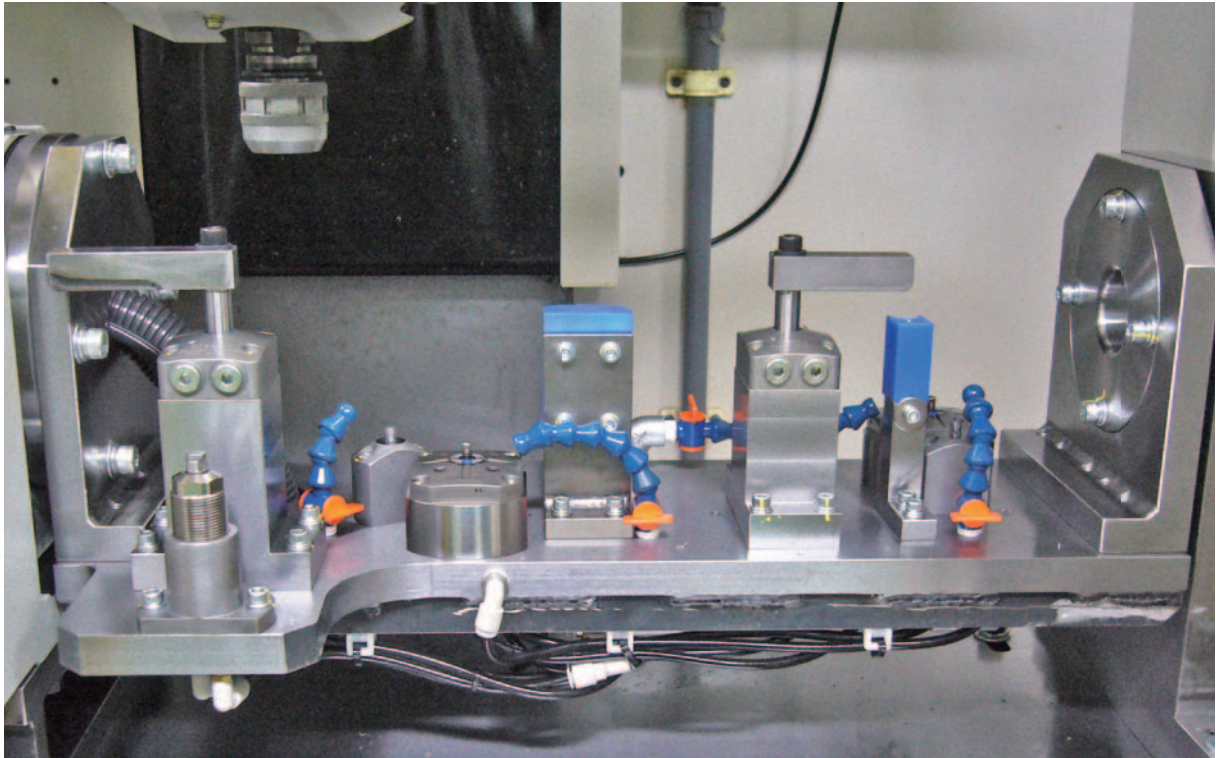

엔진부품 가공치구

CGX-N22-06×2개

클램프홀경:ø6

클램프력:1.3 kN

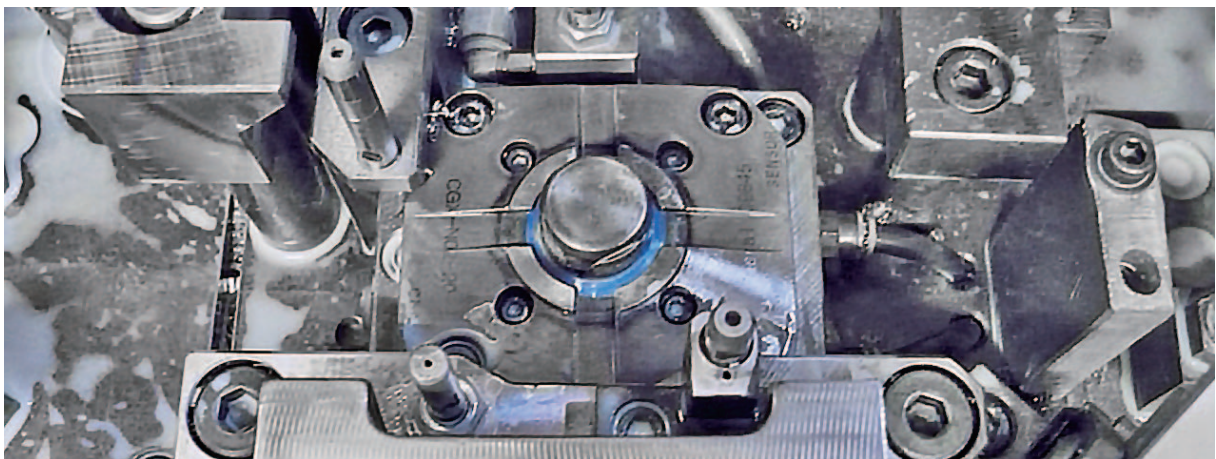

펌프커버 가공치구

CGX-N22-20×1개

클램프홀경:ø20

클램프력:0.5 kN



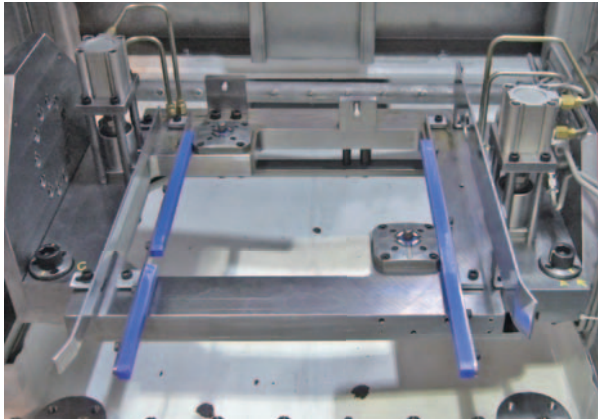

리테이너 세척 치구

CGX-N22-11×2개

클램프홀경:ø11

클램프력:1.3 kN

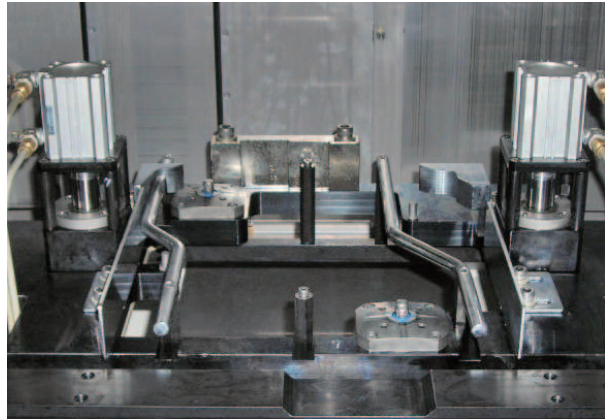

리테이너 세척 치구

CGX-N22-11×2개

클램프홀경:ø11

클램프력:1.3 kN

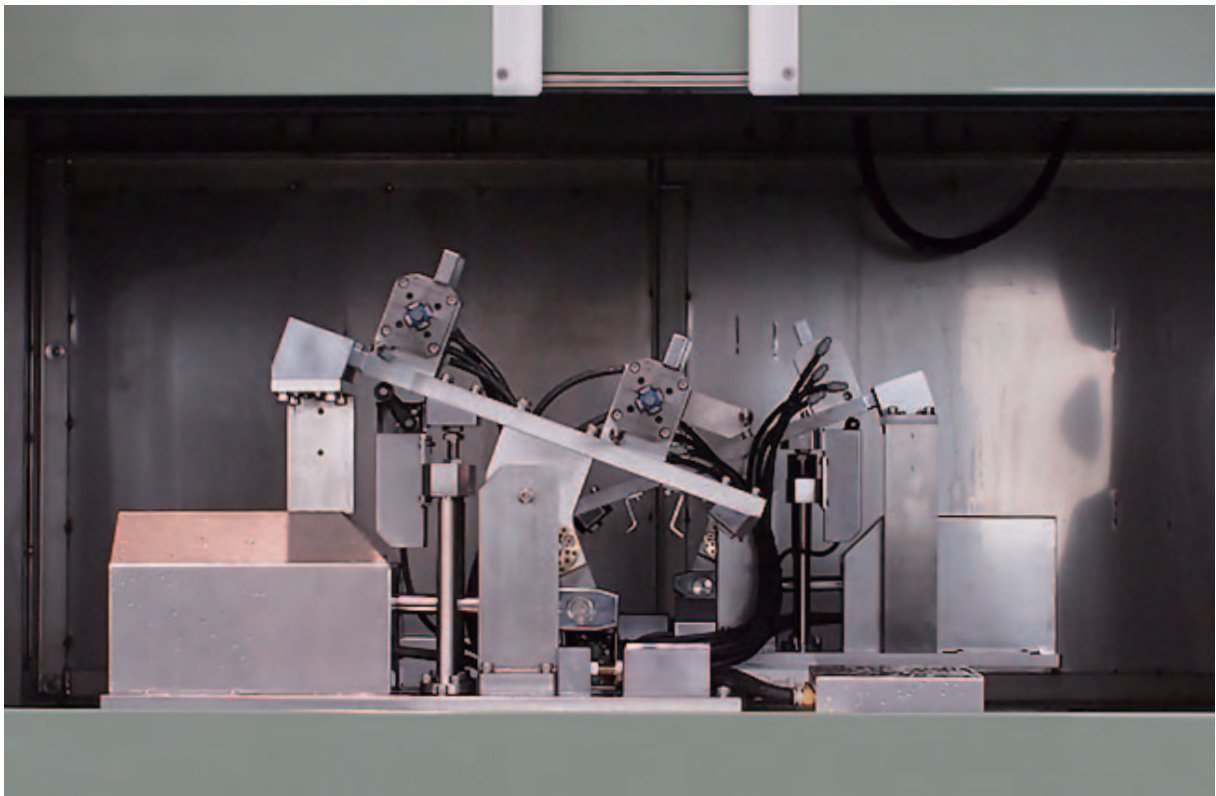

로봇세척기 치구

CGX-N22-12×2개

클램프홀경:ø12

클램프력:1.3 kN

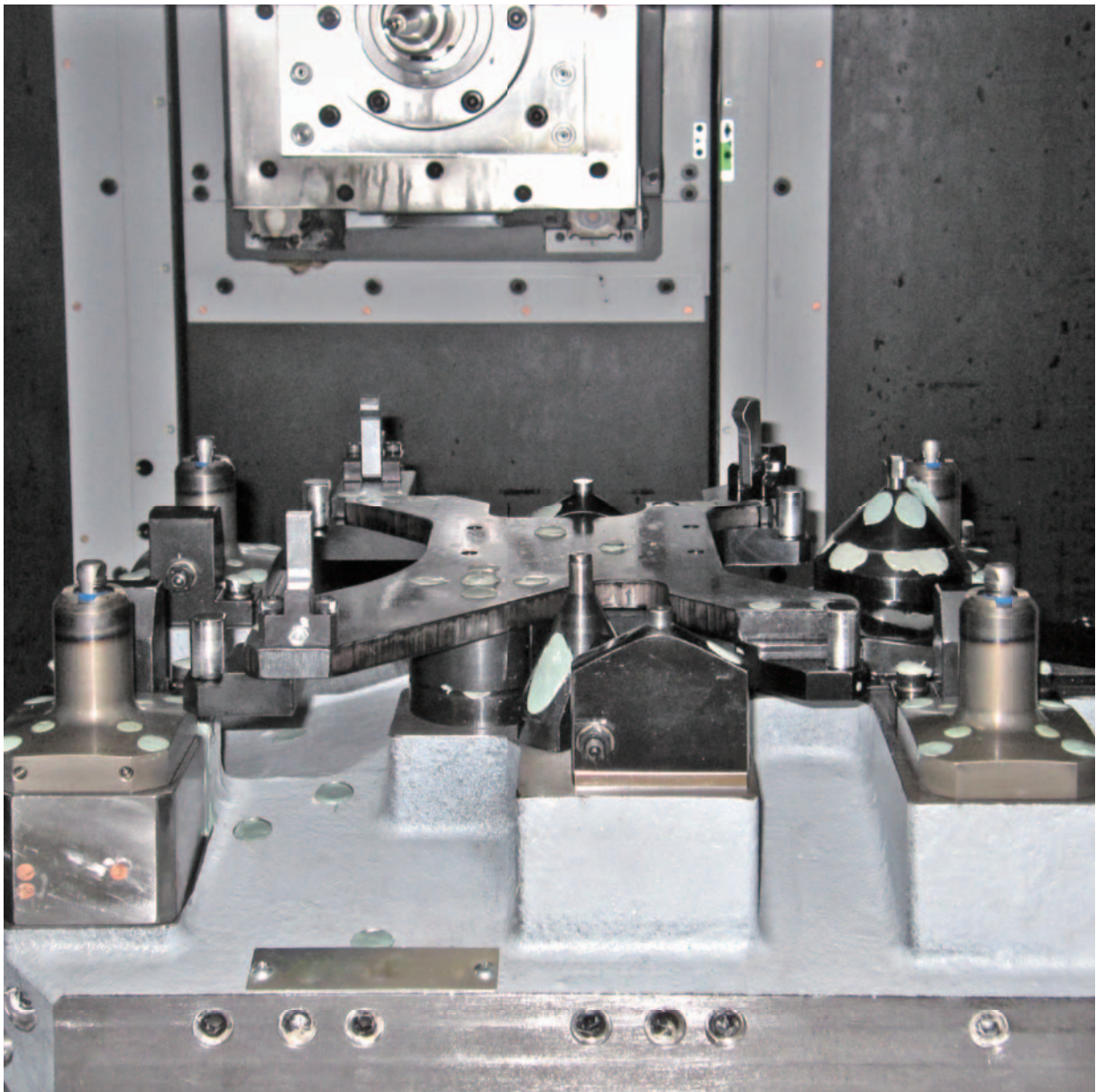

오일펌프 가공 치구

CGY-F22E095×4개

클램프홀경:  $\phi 9.5$

클램프력: 4 kN



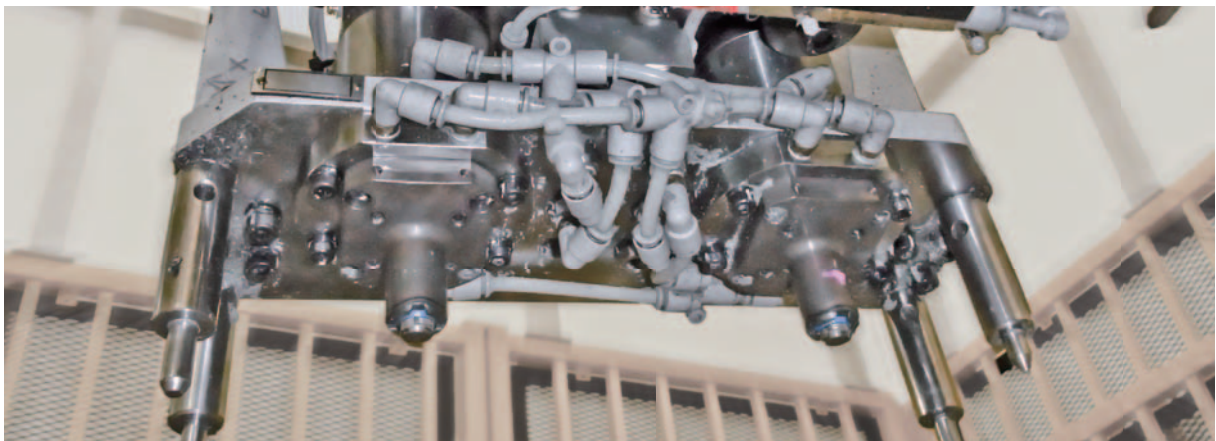
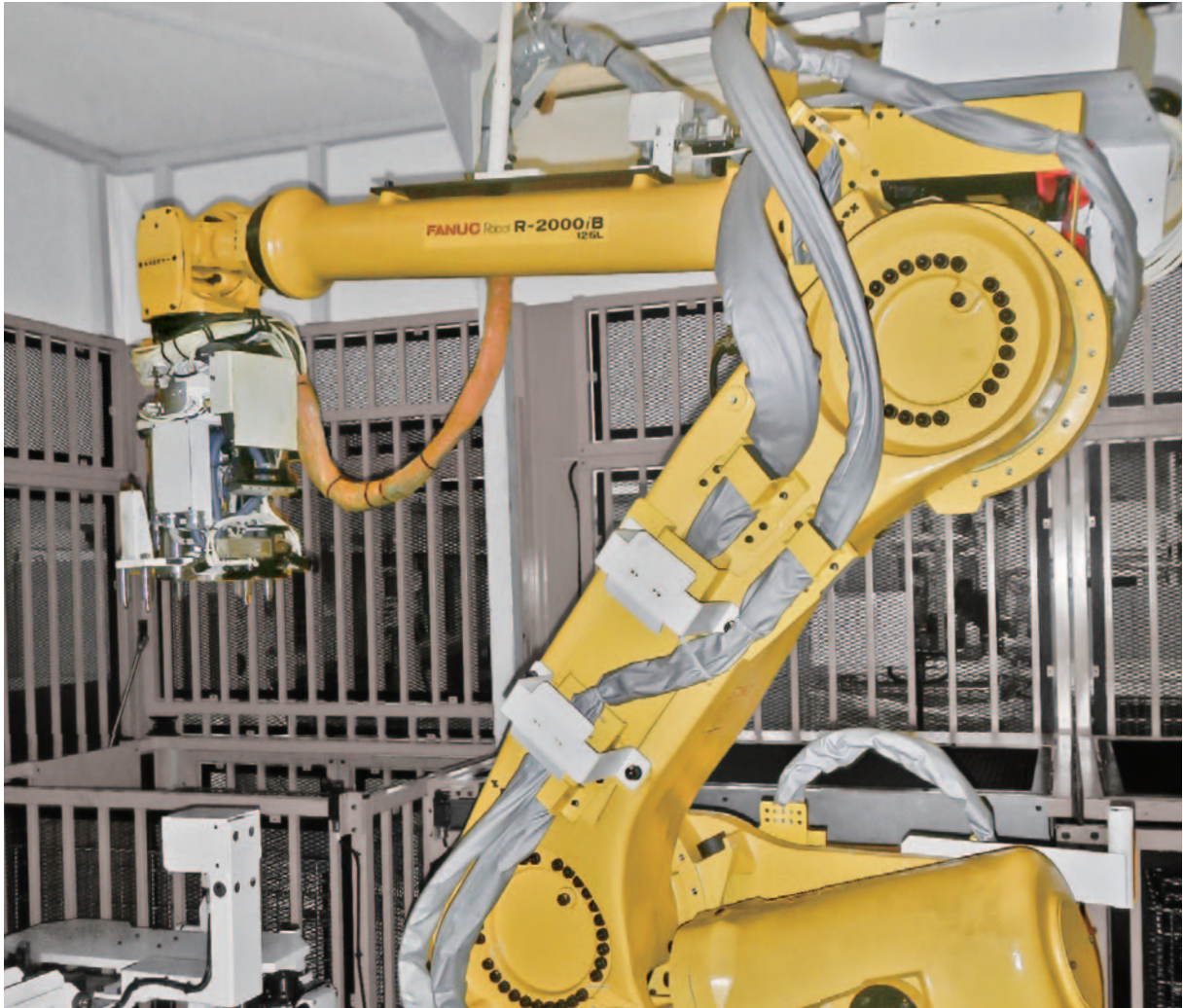

베어링캡홀드 반송지구

CGY-F32-11×2개

클램프홀경:φ11

클램프력:1.5 kN

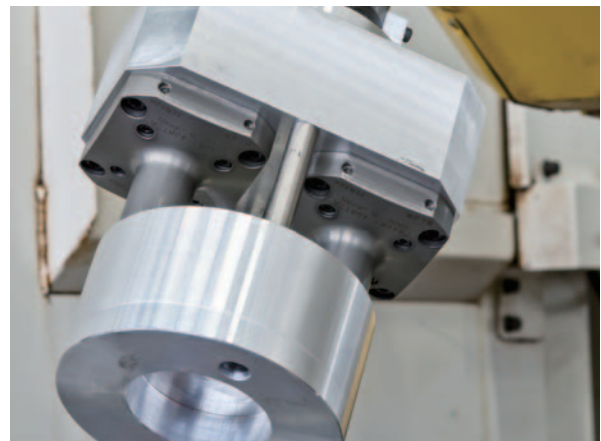

워크반송 치구

CGY-F32E11×2개

클램프홀경:φ11

클램프력:1.5 kN



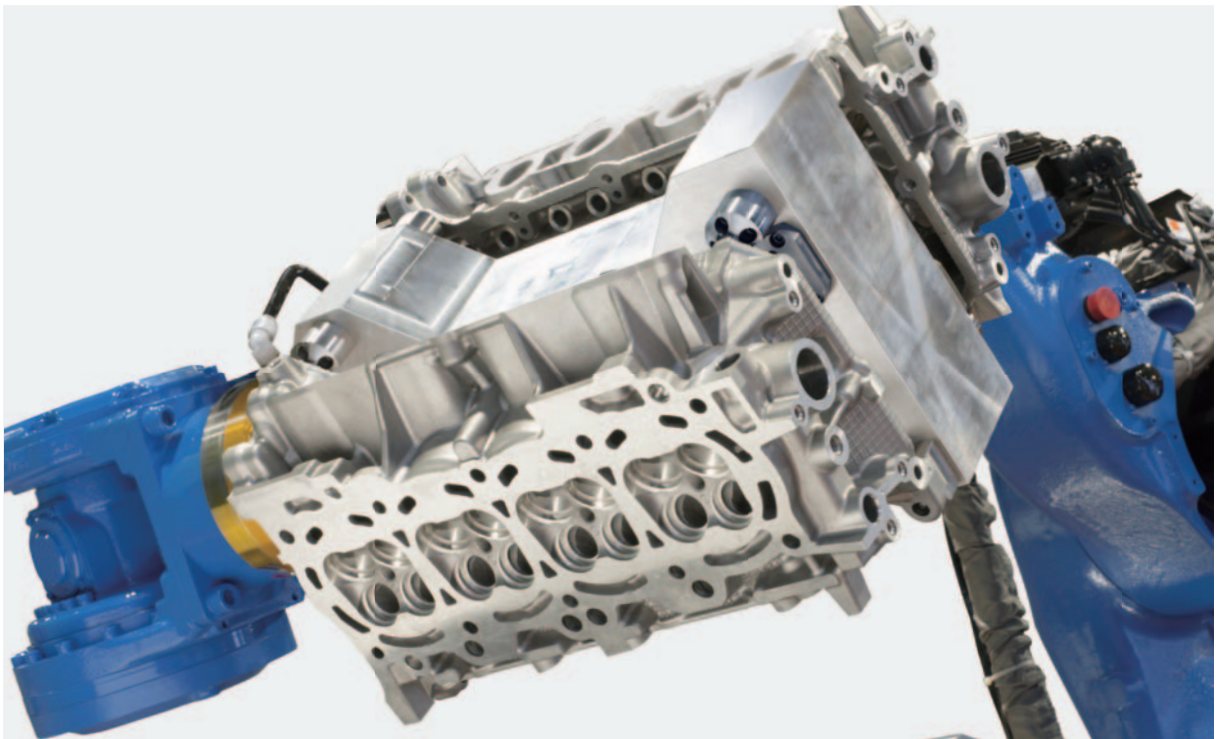
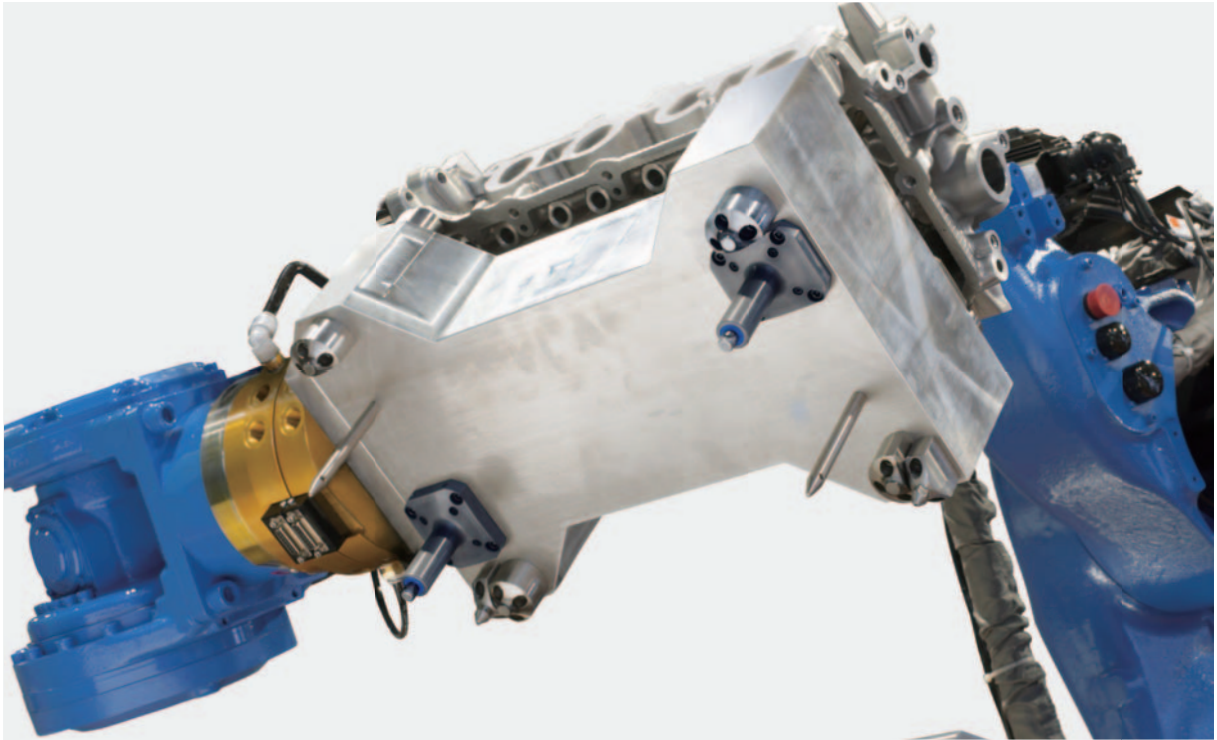

실린더헤드 반송치구

CGY-R32E11×2개

클램프홀경:φ11

클램프력:1.5 kN



실린더헤드

알루미늄다이캐스트

410×220×120 mm

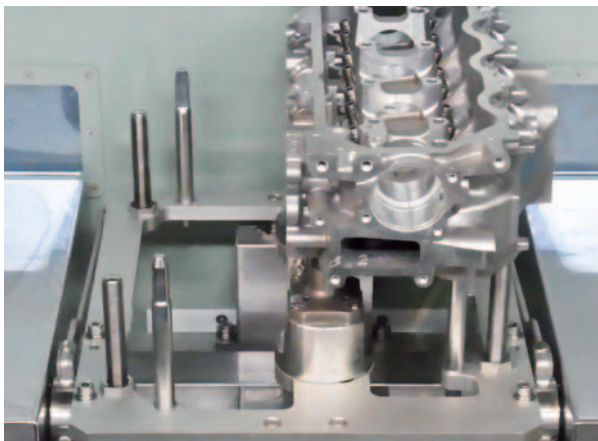

실린더헤드 세척치구

CGY-F32-12×2개

클램프홀경:  $\phi 12$

클램프력: 1.5 kN



실린더블록 세척치구

CGY-F32-13×3개

클램프홀경:  $\phi 13$

클램프력: 2.3 kN



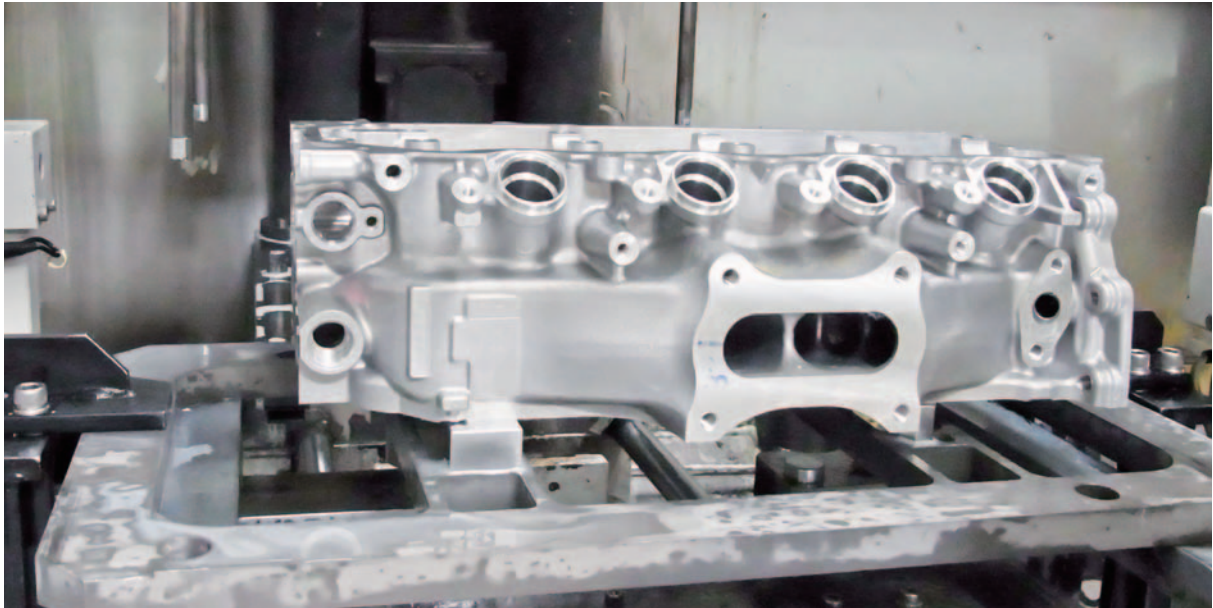

실린더 헤드

알루미늄다이캐스트

410×220×120 mm

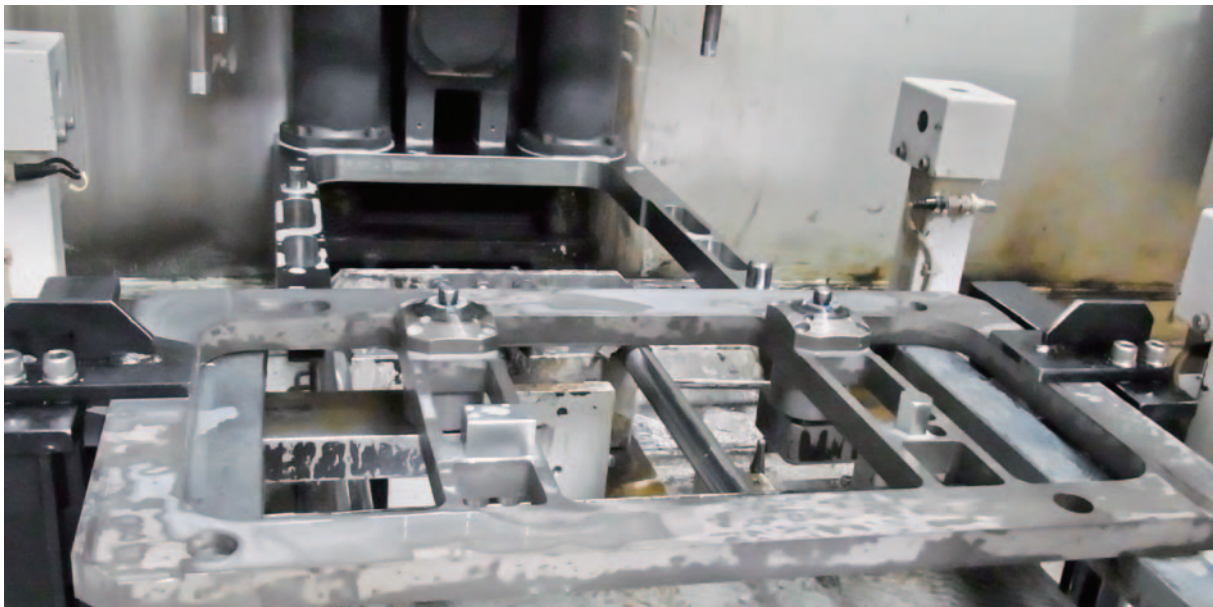

세척 지구

CGY-F42E12×2개

클램프홀경:  $\phi 12$

클램프력: 1.6 kN

# Pascal

[www.pascaleng.co.jp](http://www.pascaleng.co.jp)

## 파스칼코리아(주)

경남 창원시 성산구 상남로37, 1029  
TEL. 055-274-0971 FAX. 055-274-0972

