

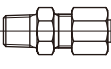

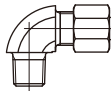

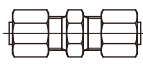

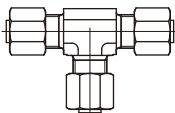
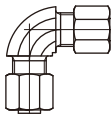
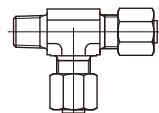
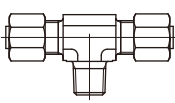
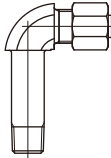

NE型钢管用卡套接头 OST钢管

厂家：伊原科技股份有限公司

品名	外形图	型号	适用管外径(mm)	连接螺纹	质量(kg)	厂家型号
连接器		ZH-8FKCT08020	ø8	R1/4	0.046	KCT08-020E
		ZH-8FKCT12030	ø12	R3/8	0.071	KCT12-030E
		ZH-8FKCT12020	ø12	R1/4	0.068	KCT12-020E
弯头螺纹接头		ZH-8FKLN08020	ø8	R1/4	0.065	KLN08-020E
		ZH-8FKLN12030	ø12	R3/8	0.105	KLN12-030E
		ZH-8FKLN12020	ø12	R1/4	0.096	KLN12-020E
管接		ZH-8FKUA08000	ø8	-	0.059	KUA08-000E
		ZH-8FKUA12000	ø12	-	0.093	KUA12-000E
三通		ZH-8FKTA08000	ø8	-	0.122	KTA08-000E
		ZH-8FKTA12000	ø12	-	0.172	KTA12-000E
弯头		ZH-8FKLA08000	ø8	-	0.077	KLA08-000E
		ZH-8FKLA12000	ø12	-	0.124	KLA12-000E
三通单螺纹接头		ZH-8FKTK08020	ø8	R1/4	0.102	KTK08-020E
		ZH-8FKTK12030	ø12	R3/8	0.143	KTK12-030E
		ZH-8FKTK12020	ø12	R1/4	0.135	KTK12-020E
三通中螺纹接头		ZH-8FKTN08020	ø8	R1/4	0.102	KTN08-020E
		ZH-8FKTN12030	ø12	R3/8	0.143	KTN12-030E
		ZH-8FKTN12020	ø12	R1/4	0.135	KTN12-020E
长弯头		ZH-8FKLL08020	ø8	R1/4	0.103	KLL08-020E
		ZH-8FKLL12030	ø12	R3/8	0.156	KLL12-030E
		ZH-8FKLL12020	ø12	R1/4	0.156	KLL12-020E

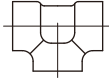
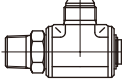

品名	外形图	型号	外径(mm)	壁厚(mm)	全长(mm)	质量(kg)
OST钢管		ZH-8FOP081200	ø8	1	2000	0.444
		ZH-8FOP121200	ø12	1.5		0.776

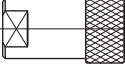
接头

品名	外形图	型号	连接螺纹	质量(kg)	厂家型号	厂家
螺纹接头		ZH-8FSNP01000	R1/8	0.013	SNP01-000J	伊原科技股份有限公司
		ZH-8FSNP02000	R1/4	0.032	SNP02-000J	
		ZH-8FSNP03000	R3/8	0.048	SNP03-000J	
异径螺纹接头		ZH-8FSRN02010	R1/4 - R1/8	0.03	SRN02-01F	
		ZH-8FSRN03020	R3/8 - R1/4	0.045	SRN03-02F	
		ZH-8FSRN04020	R1/2 - R1/4	0.078	SRN04-02F	
接箍		ZH-8FSFC02000	Rc1/4	0.075	SFC02-000F	
		ZH-8FSFC03000	Rc3/8	0.074	SFC03-000F	
内外弯头		ZH-8FSLC02000	Rc1/4 - R1/4	0.057	SLC02-000J	
		ZH-8FSLC03000	Rc3/8 - R3/8	0.1	SLC03-000J	
90°弯头		ZH-8FSLA02000	Rc1/4	0.09	SLA02-000F	
		ZH-8FSLA03000	Rc3/8	0.16	SLA03-000F	
三通		ZH-8FSTA02000	Rc1/4	0.12	STA02-000F	
		ZH-8FSTA03000	Rc3/8	0.21	STA03-000F	
旋转接头		ZH-9A2422-000	G1/4 - R1/4	0.1	-	
内六角螺塞		ZH-9A2326-200	R1/4	0.008	GJ1/4-19	株式会社 互省製作所
		ZH-9A2326-300	R3/8	0.016	GJ3/8-19	
快速接头(插塞)		ZH-8FQC02HP00	Rc1/4	0.04	2HP	日东工器 株式会社
快速接头(套筒)		ZH-8FQC02HS00	Rc1/4	0.134	2HS	

快换接头

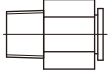
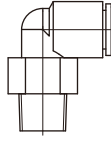
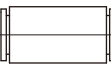
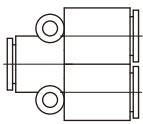
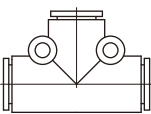
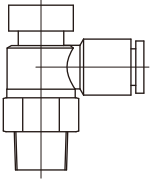
厂家：SMC株式会社

品名	外形图	型号	适合管子外径(mm)	连接螺纹	质量(kg)	厂家型号
直通接头		ZH-9A2443-080	ø6	R1/8	0.006	KQ2H06-01AS
		ZH-9A2443-090	ø6	R1/4	0.013	KQ2H06-02AS
		ZH-9A2443-150	ø10	R1/4	0.022	KQ2H10-02AS
		ZH-9A2443-160	ø10	R3/8	0.023	KQ2H10-03AS
弯头		ZH-9A2441-080	ø6	R1/8	0.005	KQ2L06-01AS
		ZH-9A2441-090	ø6	R1/4	0.015	KQ2L06-02AS
		ZH-9A2441-150	ø10	R1/4	0.022	KQ2L10-02AS
		ZH-9A2441-160	ø10	R3/8	0.045	KQ2L10-03AS
直通接管		ZH-9A2443-250	ø6	-	0.002	KQ2H06-00A
		ZH-9A2443-270	ø10	-	0.006	KQ2H10-00A
Y型接管		ZH-9A2377-020	ø6	-	0.005	KQ2U06-00A
		ZH-9A2377-040	ø10	-	0.011	KQ2U10-00A
T型接管		ZH-9A2369-020	ø6	-	0.004	KQ2T06-00A
		ZH-9A2369-400	ø10	-	0.011	KQ2T10-00A
速度控制阀 (排气节流式)		ZH-4PTR939901	ø6	R1/8	0.01	AS2201F-01-06SA
		ZH-4PTR939902	ø6	R1/4	0.018	AS2201F-02-06SA
		ZH-4PTR939903	ø10	R1/4	0.020	AS2201F-02-10SA
		ZH-4PTR939904	ø10	R3/8	0.032	AS3201F-03-10SA
品名	外形图	型号	适合管子外径(mm)	适合管接头尺寸	质量(kg)	厂家型号
插管减径接管		ZH-9A6009-Q3B	ø6	ø10	0.002	KQ2R06-10A

软管接头

厂家：清水制作所株式会社

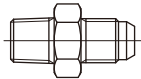
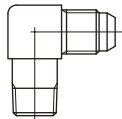
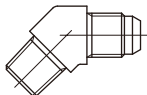
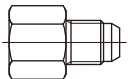
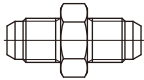
品名	外形图	型号	软管侧螺纹	连接螺纹	质量(kg)	厂家型号
直管型		ZH-8SSR130603	G1/4	R1/8	0.03	SR13 3*6
		ZH-8SSR130606	G1/4	R1/4	0.035	SR13 6
		ZH-8SSR130609	G1/4	R3/8	0.05	SR13 6*9
		ZH-8SSR130906	G3/8	R1/4	0.05	SR13 9*6
		ZH-8SSR130909	G3/8	R3/8	0.055	SR13 9
弯管型		ZH-8SSR330603	G1/4	R1/8	0.045	SR33 3*6
		ZH-8SSR330606	G1/4	R1/4	0.05	SR33 6
		ZH-8SSR330609	G1/4	R3/8	0.08	SR33 6*9
		ZH-8SSR330906	G3/8	R1/4	0.075	SR33 9*6
		ZH-8SSR330909	G3/8	R3/8	0.08	SR33 9
45°弯管型		ZH-8SSR350603	G1/4	R1/8	0.035	SR35 3*6
		ZH-8SSR350606	G1/4	R1/4	0.04	SR35 6
		ZH-8SSR350609	G1/4	R3/8	0.06	SR35 6*9
		ZH-8SSR350906	G3/8	R1/4	0.06	SR35 9*6
		ZH-8SSR350909	G3/8	R3/8	0.065	SR35 9
内螺纹直管型		ZH-8SSR170606	G1/4	Rc1/4	0.025	SR17 6
		ZH-8SSR170909	G3/8	Rc3/8	0.055	SR17 9
品名	外形图	型号	软管侧螺纹		质量(kg)	厂家型号
管接头		ZH-8SSR140606	G1/4		0.05	SR14 6
		ZH-8SSR140909	G3/8		0.075	SR14 9

液压软管

厂家：霓达株式会社

规格	外形图	型号	全长(mm)	质量(kg)
标准 G1/4	 <p>铆接零件:厂家型号 SE-PF-03 软管:厂家型号 3000-03</p>	ZH-8FHC030500	500	0.16
		ZH-8FHC030600	600	0.168
		ZH-8FHC030700	700	0.176
		ZH-8FHC030800	800	0.183
		ZH-8FHC030900	900	0.191
		ZH-8FHC031000	1000	0.198
标准 G3/8	 <p>铆接零件:厂家型号 SE-PF-06 软管:厂家型号 3000-06</p>	ZH-8FHC060500	500	0.264
		ZH-8FHC060600	600	0.278
		ZH-8FHC060700	700	0.292
		ZH-8FHC060800	800	0.306
		ZH-8FHC060900	900	0.32
		ZH-8FHC061000	1000	0.334
护管弹簧 G1/4	 <p>铆接零件:厂家型号 SE-PF-03 软管:厂家型号 3000-03</p>	ZH-8FHD030500	500(※)	0.259
		ZH-8FHD030600	600(※)	0.286
		ZH-8FHD030700	700(※)	0.314
		ZH-8FHD030800	800	0.32
		ZH-8FHD030900	900	0.341
		ZH-8FHD031000	1000	0.361
护管弹簧 G3/8	 <p>铆接零件:厂家型号 SE-PF-06 软管:厂家型号 3000-06</p>	ZH-8FHD060500	500(※)	0.429
		ZH-8FHD060600	600(※)	0.485
		ZH-8FHD060700	700(※)	0.538
		ZH-8FHD060800	800	0.477
		ZH-8FHD060900	900	0.515
		ZH-8FHD061000	1000	0.542

厂家：普利司通股份有限公司

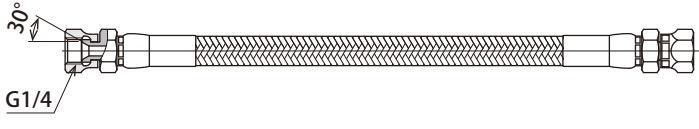
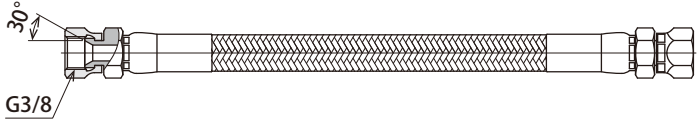
规格	外形图	型号	全长(mm)	质量(kg)
金属网编织 G1/4	 <p>铆接零件:厂家型号 JY04F 软管:厂家型号 KB04-GG</p>	ZH-8BDE040500	500	0.27
		ZH-8BDE040600	600	0.292
		ZH-8BDE040700	700	0.314
		ZH-8BDE040800	800	0.336
		ZH-8BDE040900	900	0.358
		ZH-8BDE041000	1000	0.38
金属网编织 G3/8	 <p>铆接零件:厂家型号 SY06F 软管:厂家型号 KB06-GG</p>	ZH-8BDE060500	500	0.37
		ZH-8BDE060600	600	0.4
		ZH-8BDE060700	700	0.43
		ZH-8BDE060800	800	0.46
		ZH-8BDE060900	900	0.49
		ZH-8BDE061000	1000	0.52

(※) 敝社专用长度。

分流器 WBB4

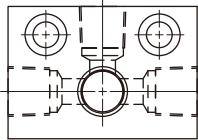
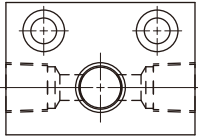
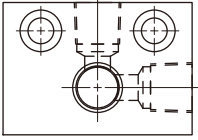
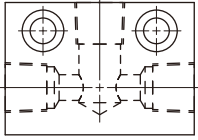
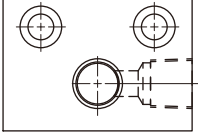
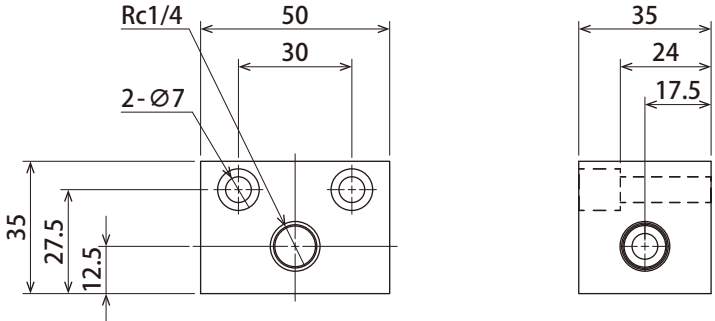
接口数量	外形图		
4 接口	<p style="text-align: center;">型号 WBB4-4A</p> 		
3 接口	<p style="text-align: center;">型号 WBB4-3A</p> 	<p style="text-align: center;">型号 WBB4-3B</p> 	<p style="text-align: center;">型号 WBB4-3C</p> 
2 接口	<p style="text-align: center;">型号 WBB4-2A</p> 		
<p>外形尺寸图</p>  <p style="text-align: center;">质量 : 0.42 kg</p> <p style="text-align: center;">参考：安装螺栓 M6x30 (型号ZH-8BSCM06030)</p>			

不附带安装螺栓。请对表中的安装螺栓另行订货。

分流器 WBB6

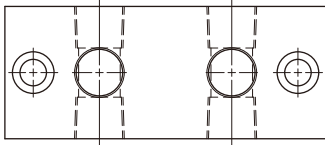
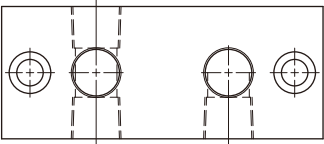
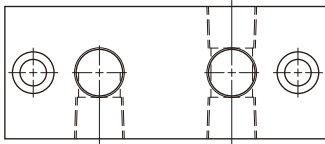
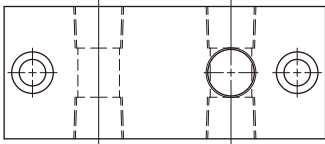
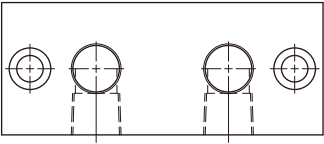
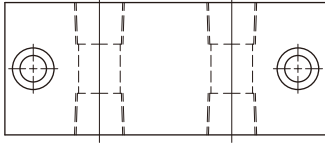
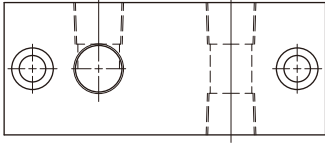
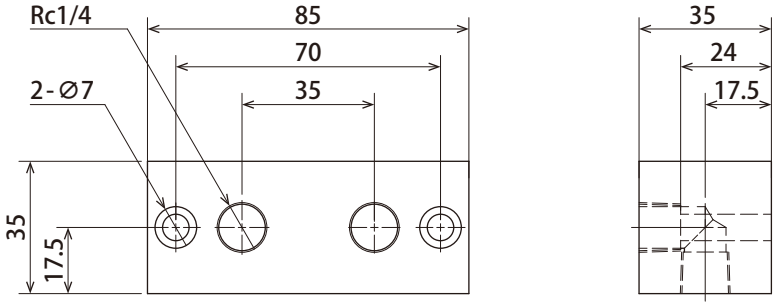
接口数量	外形图
6 接口	<p style="text-align: center;">型号 WBB6-6A</p> 
5 接口	<div style="display: flex; justify-content: space-around;"> <div style="text-align: center;"> <p>型号 WBB6-5A</p>  </div> <div style="text-align: center;"> <p>型号 WBB6-5B</p>  </div> <div style="text-align: center;"> <p>型号 WBB6-5C</p>  </div> </div>
4 接口	<div style="display: flex; justify-content: space-around;"> <div style="text-align: center;"> <p>型号 WBB6-4A</p>  </div> <div style="text-align: center;"> <p>型号 WBB6-4B</p>  </div> <div style="text-align: center;"> <p>型号 WBB6-4C</p>  </div> </div>
	<p style="text-align: center;"><u>外形尺寸图</u></p>  <p style="text-align: center;">质量 : 0.61 kg</p> <p style="text-align: center;">参考：安装螺栓 M6x30 (型号ZH-8BSCM06030)</p>

不附带安装螺栓。请对表中的安装螺栓另行订货。

分流器 WBA

型 号	外形图	连接 螺 纹	质量(kg)
WBA 9	<p style="text-align: center;">参考: 安装螺栓 M6x30 (型号ZH-8BSCM06030) 弹簧垫圈 M6 (型号ZH-8WS2M06000)</p>	9-Rc1/4	0.575
WBA 4-03 (订货生产)	<p style="text-align: center;">参考: 安装螺栓 M8x35 (型号ZH-8BSCM08035) 弹簧垫圈 M8 (型号ZH-8WS2M08000)</p>	4-Rc3/8	0.845
WBA 06-03 (订货生产)	<p style="text-align: center;">参考: 安装螺栓 M8x35 (型号ZH-8BSCM08035) 弹簧垫圈 M8 (型号ZH-8WS2M08000)</p>	6-Rc3/8	1.165
WBA 09-03 (订货生产)	<p style="text-align: center;">参考: 安装螺栓 M8x35 (型号ZH-8BSCM08035) 弹簧垫圈 M8 (型号ZH-8WS2M08000)</p>	9-Rc3/8	1.24

不附带安装螺栓。请对表中的安装螺栓及弹簧垫圈另行订货。

充甘油压力表

厂家：株式会社淀川计器制作所

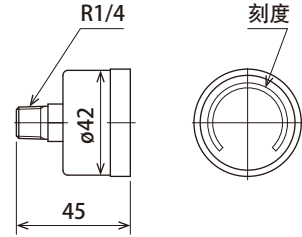
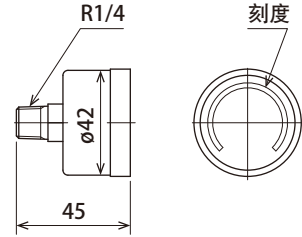
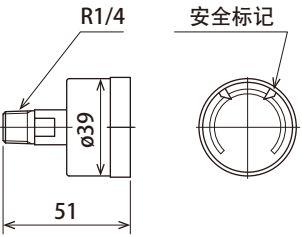
型号	外形图	最大刻度	用途	刻度色标	质量(kg)	厂家型号
SK-HC-9A35331414		1MPa	压力表(气压)	0.45~0.5MPa绿色 其他红色	0.11	IADGT-R2-42x1M-414
SK-HC-9A35331410		1MPa	压力表(气压)	无色标	0.11	IADGT-R2-42x1M-410
SK-HC-9A3533345G		40MPa	油 压 表	无色标、 附安全标记	0.105	IADGU-R2-39x40M-45G

使用例

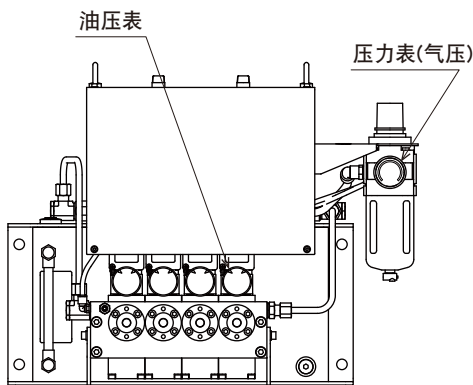

控制单元
HCPD-H22DDDD-U

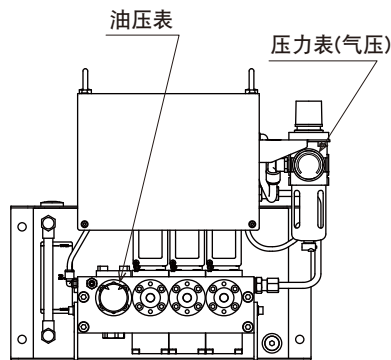

控制单元
HCSD-H2EDDD

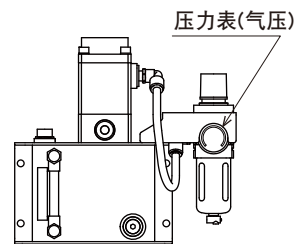

动力单元
HUT-2

管夹

厂家：株式会社正和

品名	外形图	型号	适用管外径 (mm)	A(mm)	B(mm)	质量(kg)	厂家型号
单侧固定式1联管夹		ZH-9A2552-032	ø8	22.2	12	0.003	PZ0108
		ZH-9A2552-052	ø12	26.4	16	0.007	PZ0112
单侧固定式2联管夹		ZH-9A2552-082	ø8	30.6	12	0.004	PZ0208
		ZH-9A2552-102	ø12	38.8	16	0.009	PZ0212
单侧固定式3联管夹		ZH-9A2552-132	ø8	38.8	12	0.005	PZ0308
		ZH-9A2552-152	ø12	51	16	0.011	PZ0312
双侧固定式1联管夹		ZH-9A2552-031	ø8	34	12	0.004	PZ1108
		ZH-9A2552-051	ø12	38	16	0.008	PZ1112
双侧固定式2联管夹		ZH-9A2552-081	ø8	42.4	12	0.005	PZ1208
		ZH-9A2552-101	ø12	50.4	16	0.01	PZ1212
双侧固定式3联管夹		ZH-9A2552-131	ø8	50.6	12	0.006	PZ1308
		ZH-9A2552-151	ø12	62.6	16	0.013	PZ1312

不附带安装螺栓。请对M5x10垫圈组合十字槽平头小螺钉P=4 (型号8BC510P3U0) 另行订货。

管夹(附底板)

厂家：相互工业株式会社

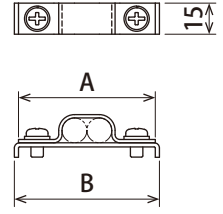
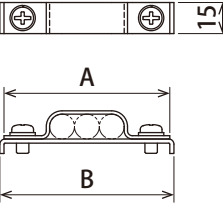
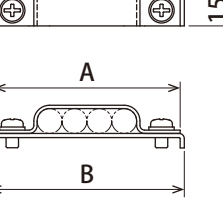
品名	外形图	型号	适用管外径 (mm)	A(mm)	B(mm)	质量(kg)	厂家型号
管夹(附底板)2联		ZH-9A2575-080	ø8	58	62	0.037	8x2W, Z-9
		ZH-9A2575-200	ø12	66	70	0.041	12x2W, Z-3
管夹(附底板)3联		ZH-9A2575-090	ø8	66	70	0.04	8x3W, Z-3
		ZH-9A2575-210	ø12	80	84	0.047	12x3W, Z-5
管夹(附底板)4联		ZH-9A2575-100	ø8	74	78	0.043	8x4W, Z-4
		ZH-9A2575-220	ø12	90	94	0.052	12x4W, Z-6