

Pascal

New **Valve stand**

New 阀座



New 阀座 垂直型 model MBA-08RV

5,500 kN 注塑机 固定侧 实施例



New 阀座 垂直型 model MBA-08LV

5,500 kN 注塑机 可动侧 实施例

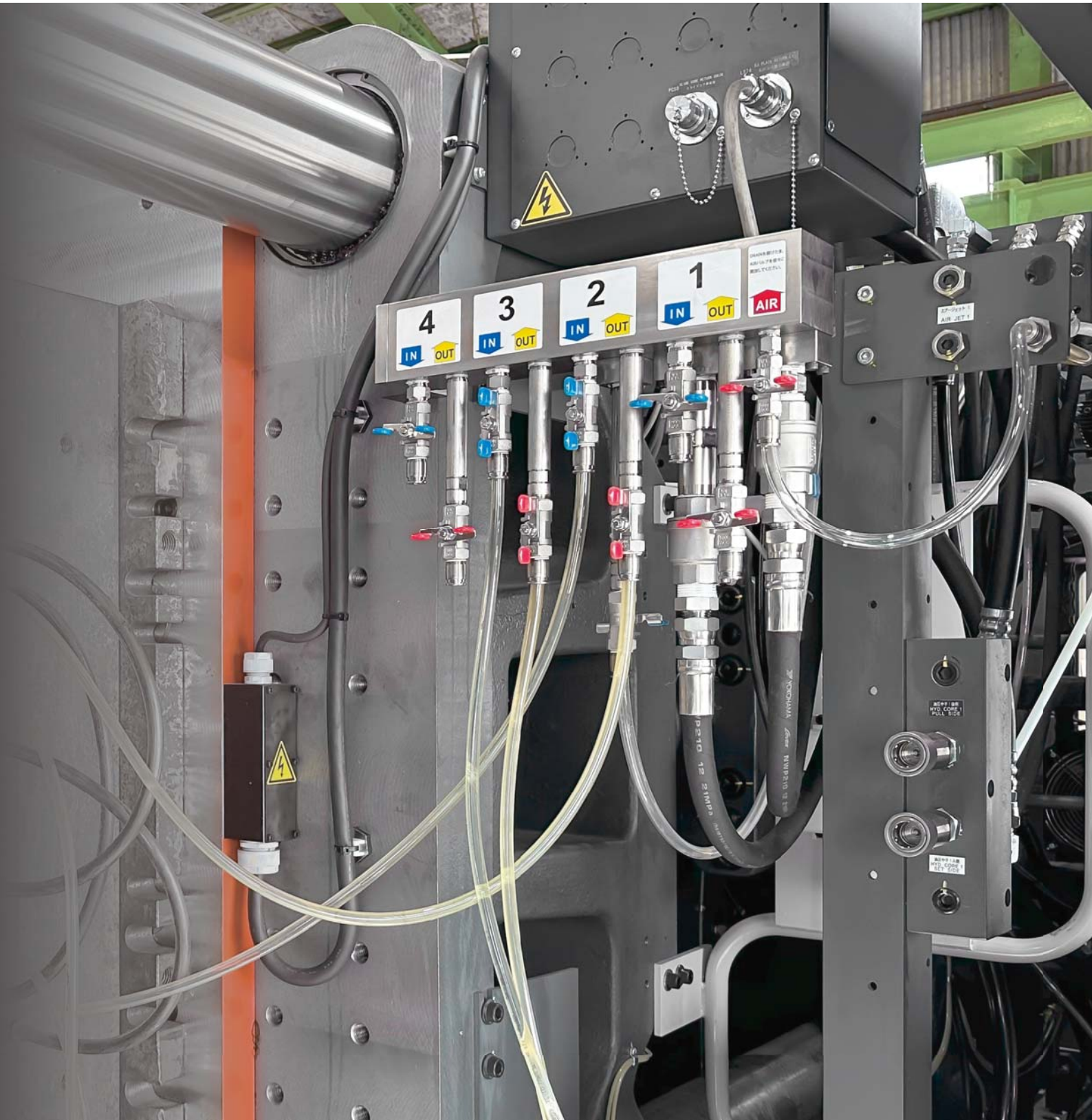

对温控管道进行大胆改革。

- 软管排列整齐防止管道错接
- 提高配管工效
- 多根软管排列工整



5500 kN 注塑机 实施例 New 阀座 垂直型 4回路 8接口 MBA-08RV

3回路6接口、气压+排水回路

model MBA-06RVS

后视图

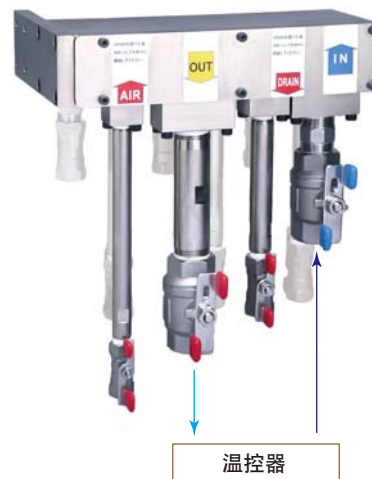
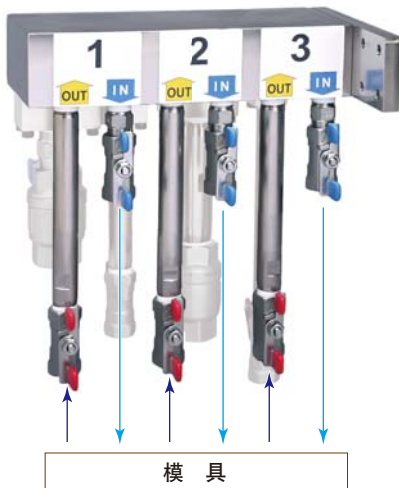

规格

适合流体	水、空气、矿物油	
最小通行面积	1次侧接口 : 314 mm ²	2次侧接口 : 38.4 mm ²
最高使用压力	1.0 MPa	
最高使用温度	150 °C	
材质	分流管	钢 (化学镀镍)
	球阀	不锈钢

型号表示

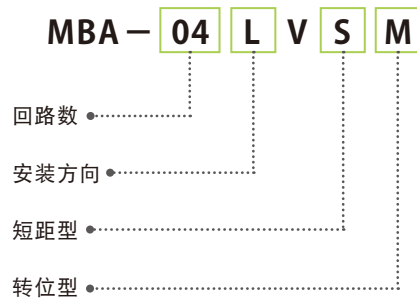

回路数 (接口数)

MBA-04 : 2回路 (4接口)
 MBA-06 : 3回路 (6接口)
 MBA-08 : 4回路 (8接口)

安装方向

L : 左侧

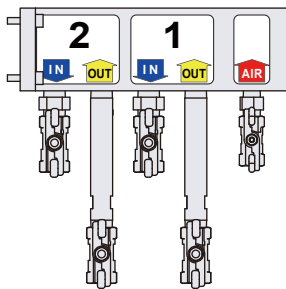

R : 右侧

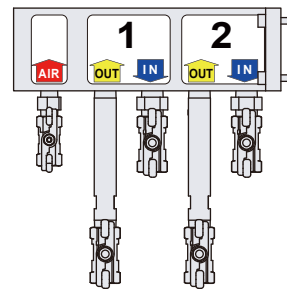

短距型

(总长度较短的紧凑型。不包括 MBA-04 型。)

无符号 : 标准型号

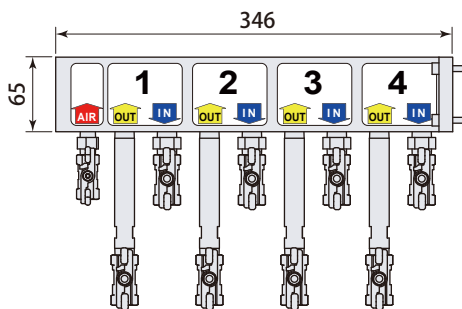

S : 短距型

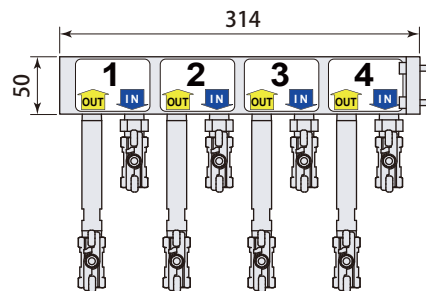

转位型

(可锁定 0°、45°、90°角度的型号)

M : 转位型

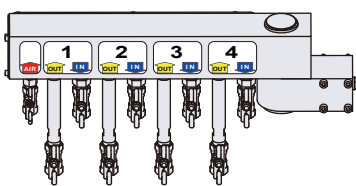

角度锁定 0°

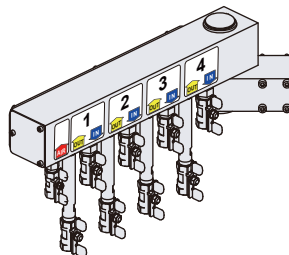

45°

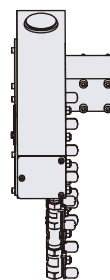

90°

2回路(4接口)

标准型号

model **MBA-04** R V

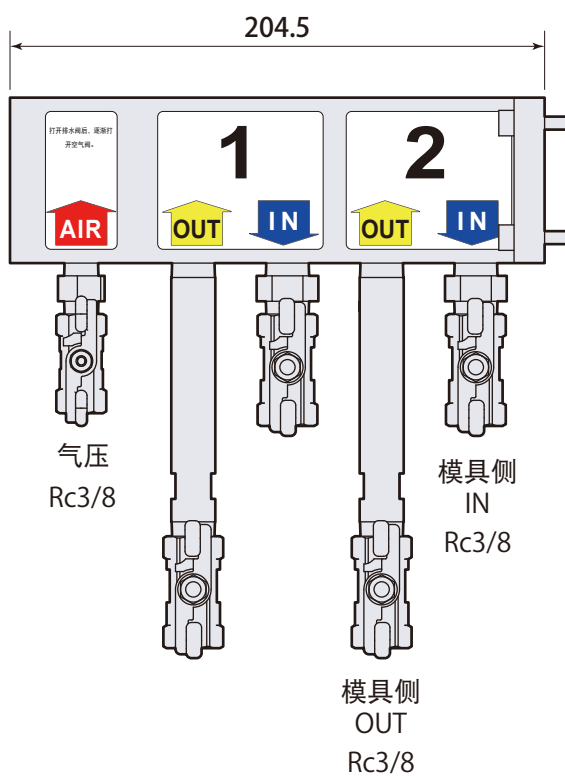

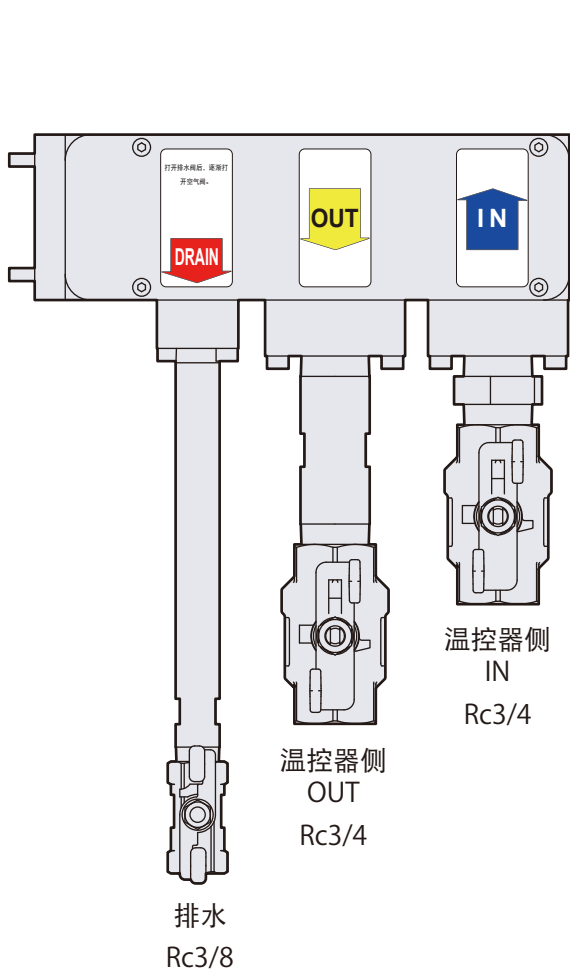

后视图

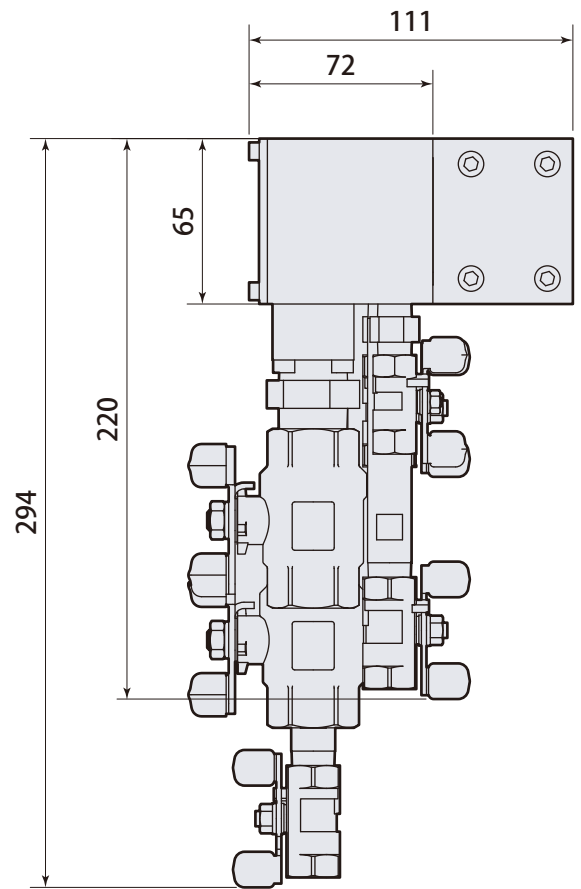

型号表示 R:如图所示 L:左右相反

3回路(6接口)

标准型号

model MBA-06RV

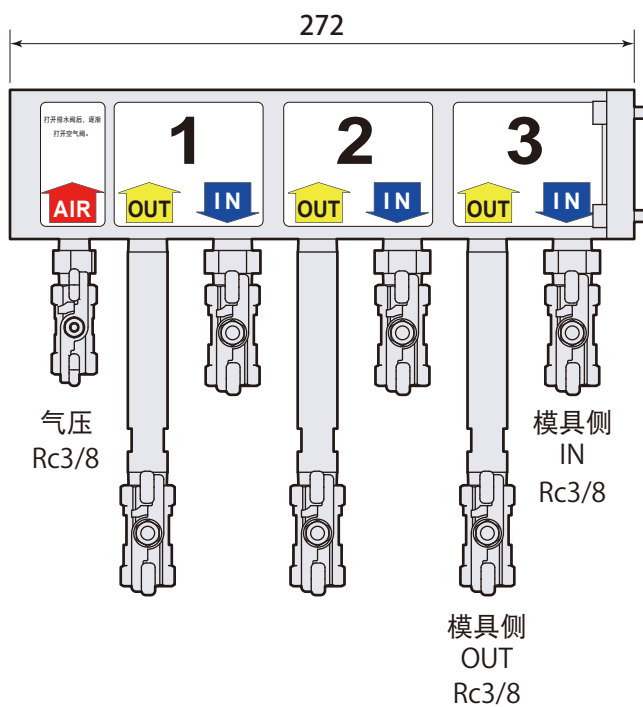

3回路(6接口)

短距型

model MBA-06RVS

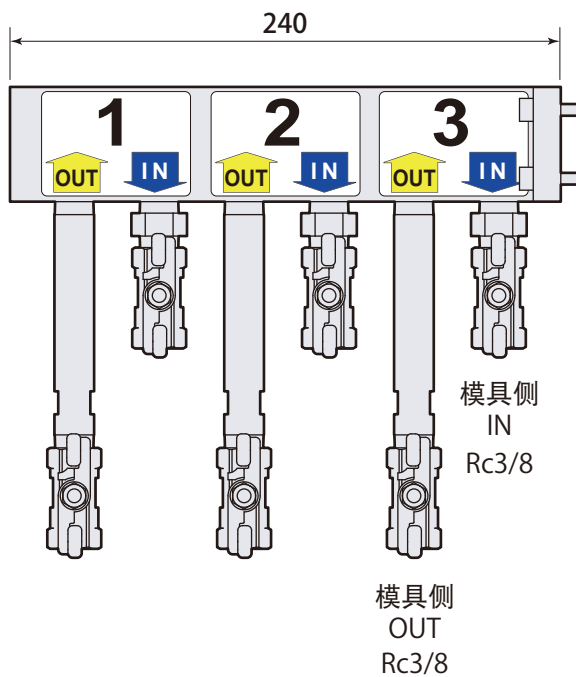

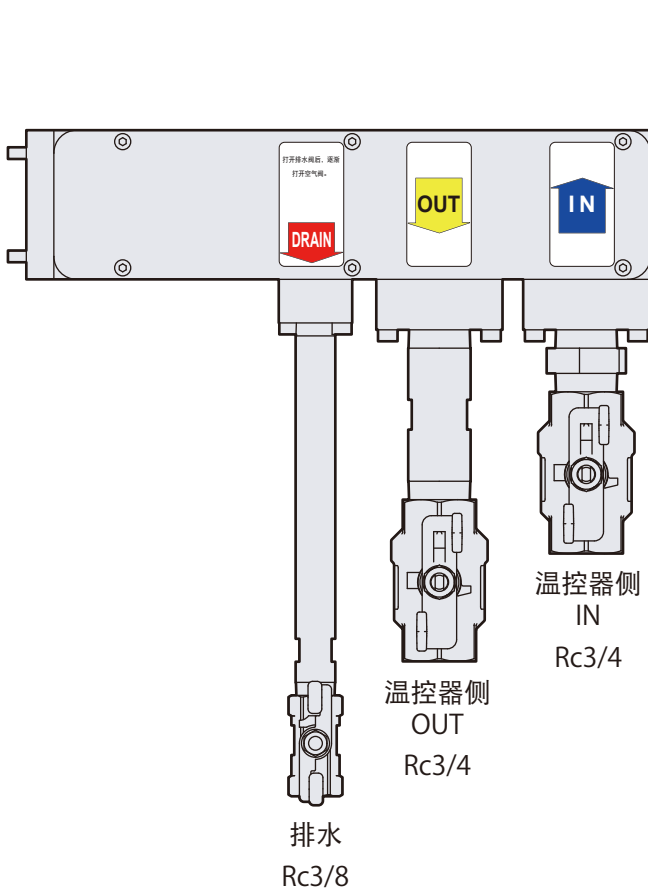

后视图

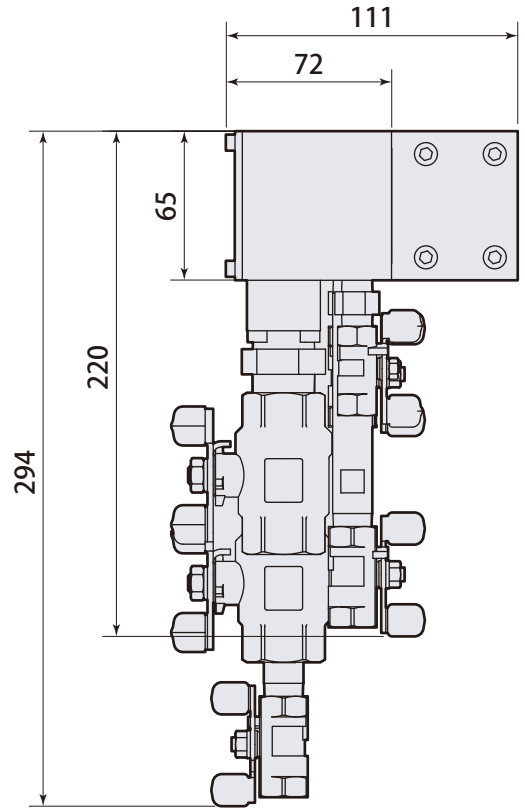

型号表示 R:如图所示 L:左右相反

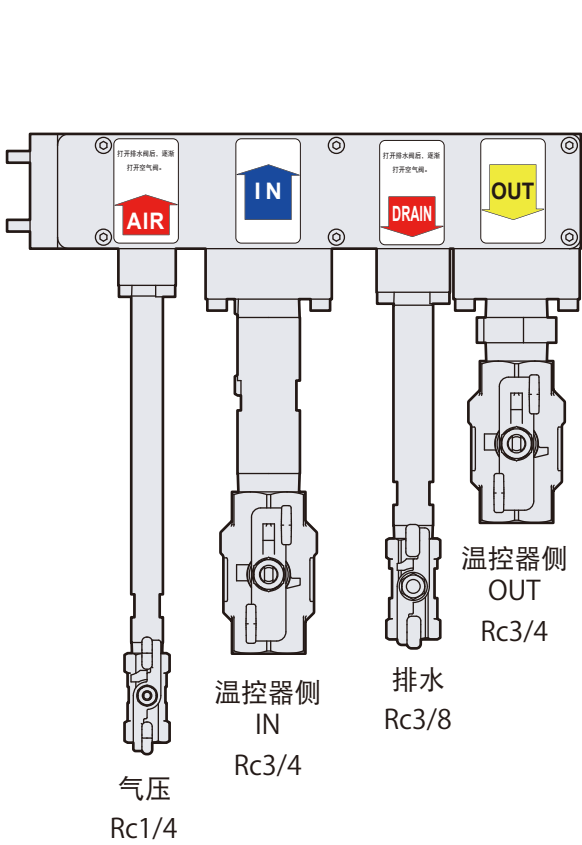

后视图

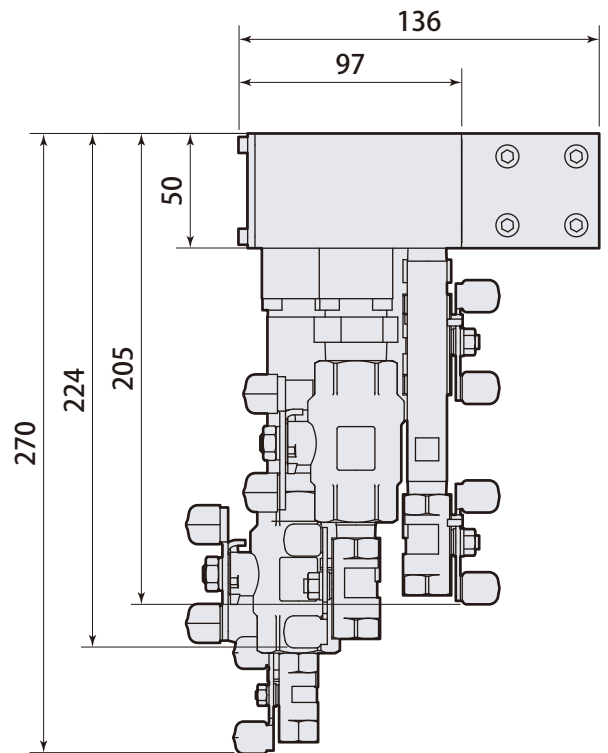

型号表示 R:如图所示 L:左右相反

4回路(8接口)

标准型号

model MBA-08RV

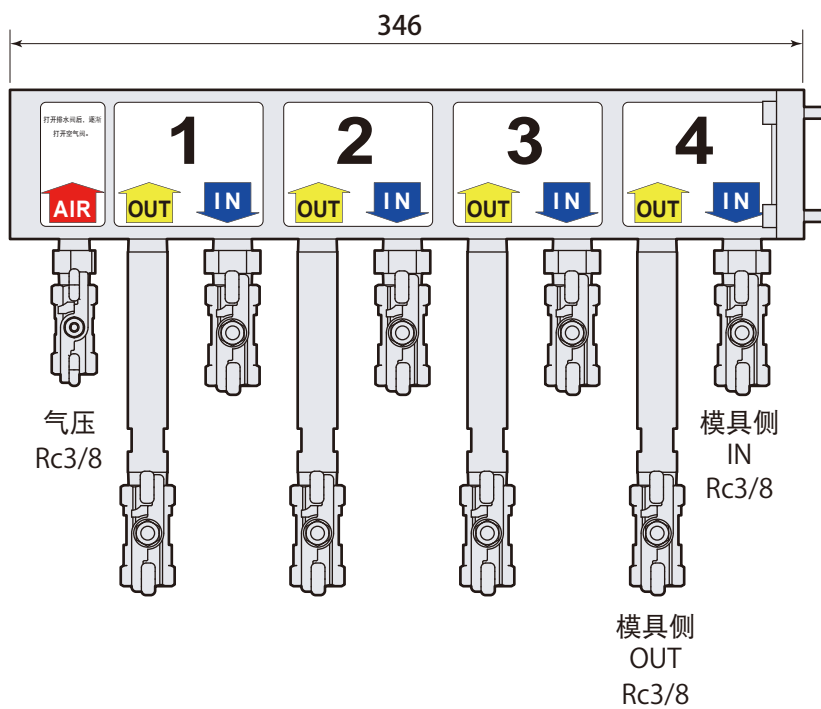

4回路(8接口)

短距型

model MBA-08RVS

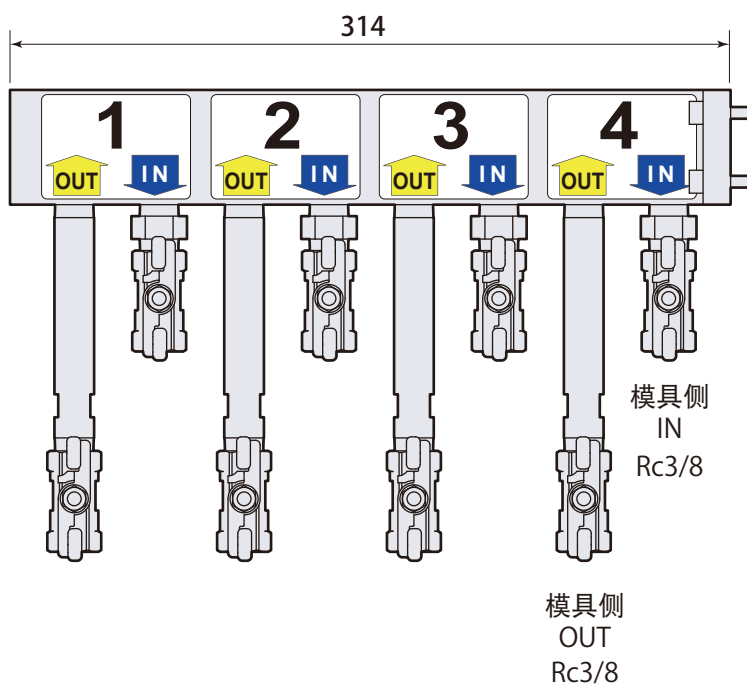

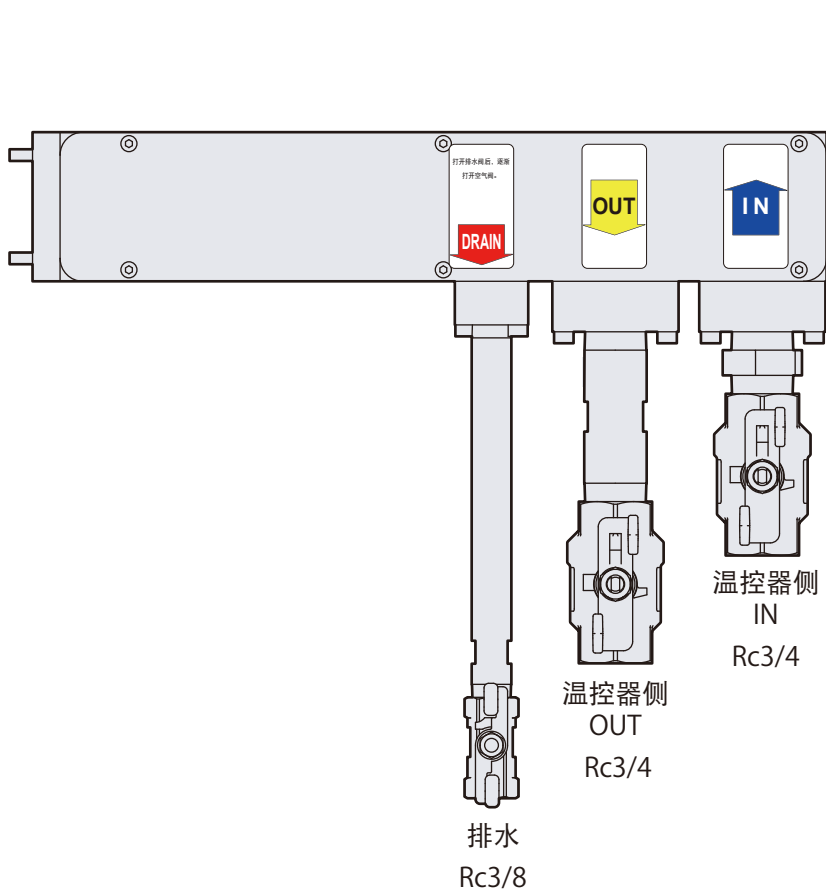

后视图

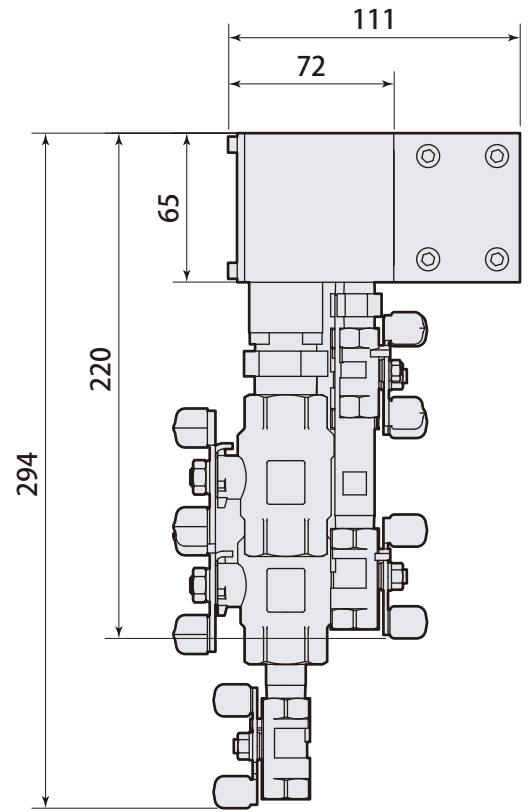

型号表示 R: 如图所示 L: 左右相反

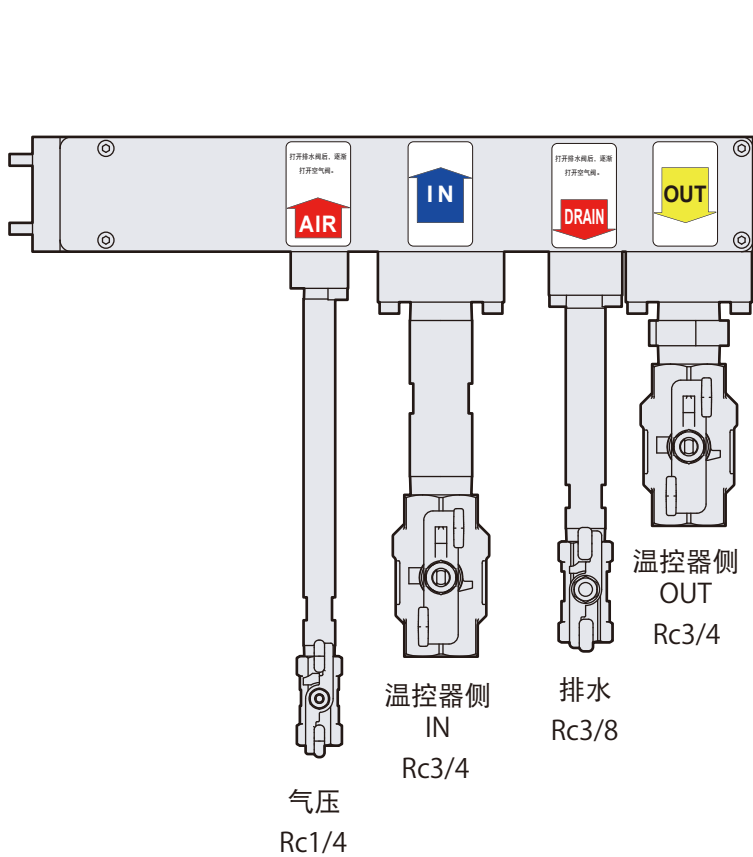

后视图

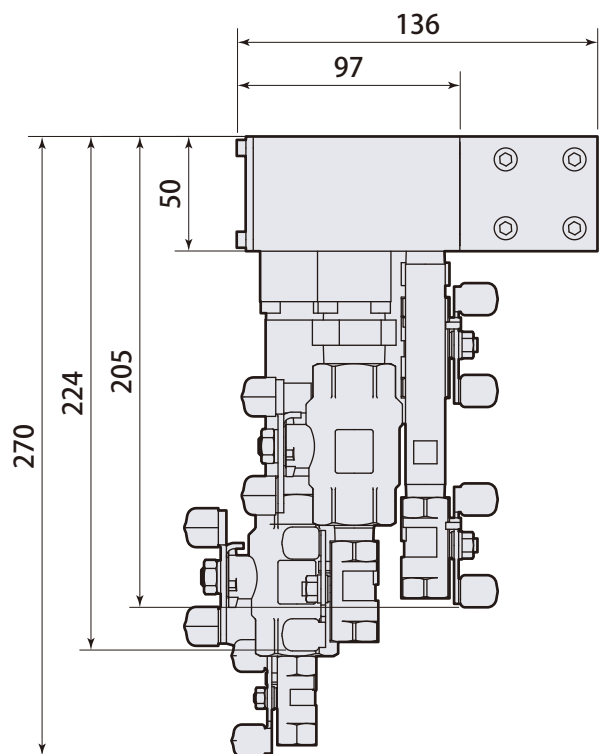

型号表示 R: 如图所示 L: 左右相反

2回路(4接口)

转位型

model **MBA-04R** VM

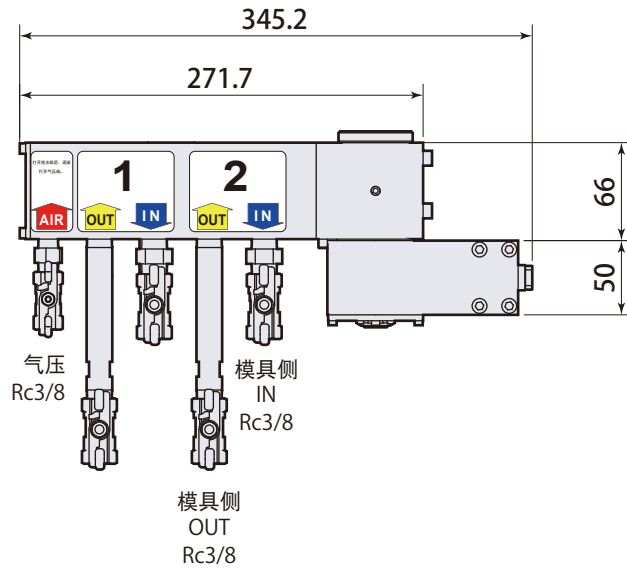

3回路(6接口)

转位型

model **MBA-06R** VM

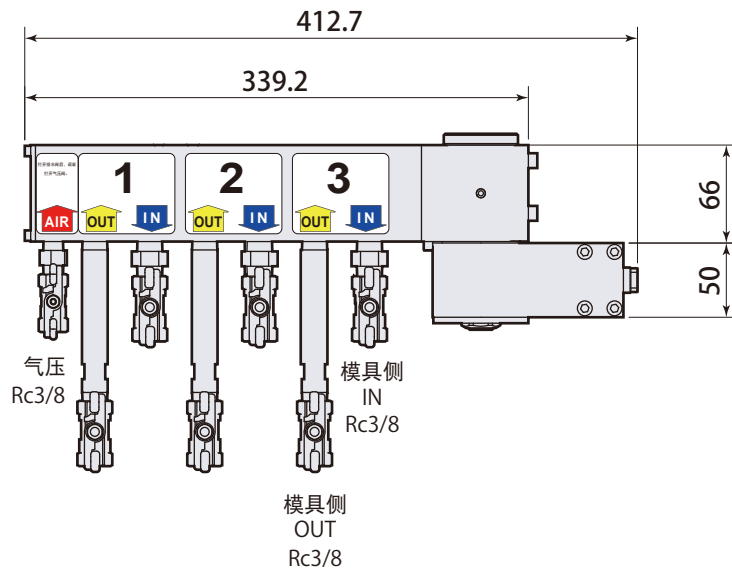

4回路(8接口)

转位型

model **MBA-08R** VM

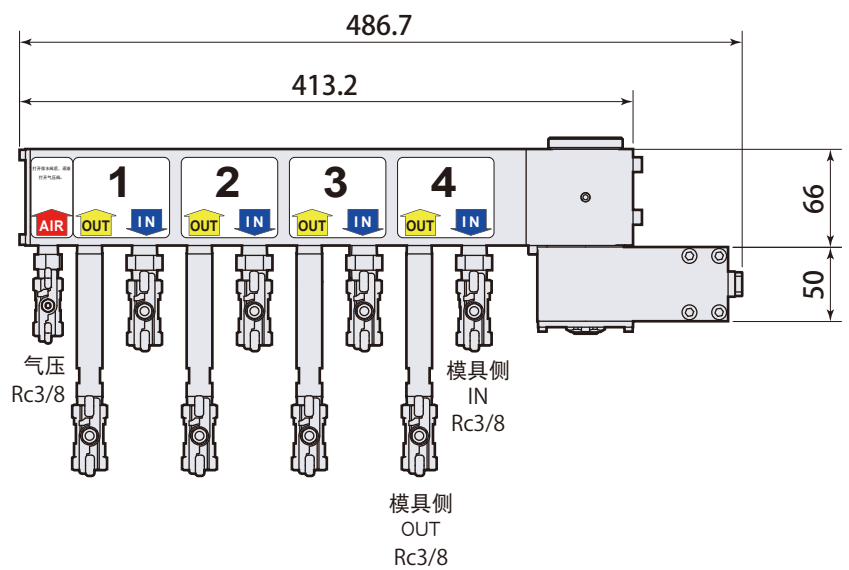

后视图

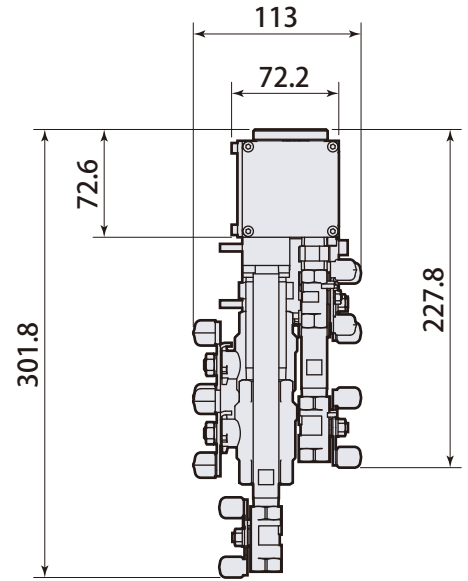
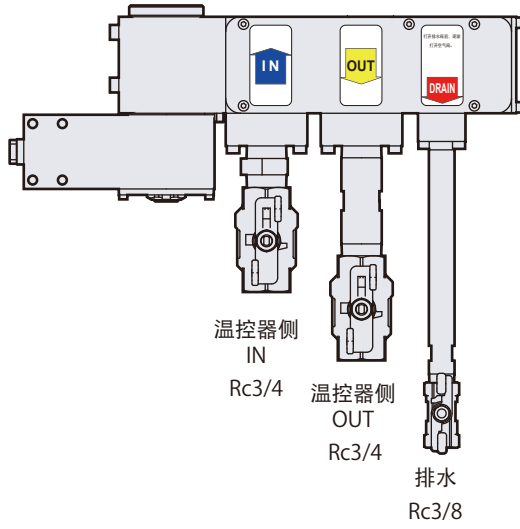

后视图

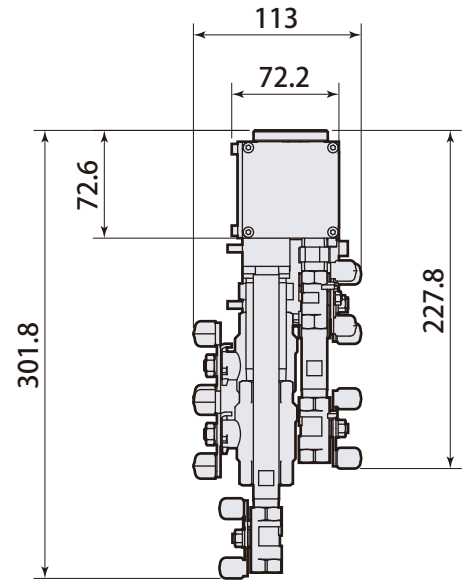
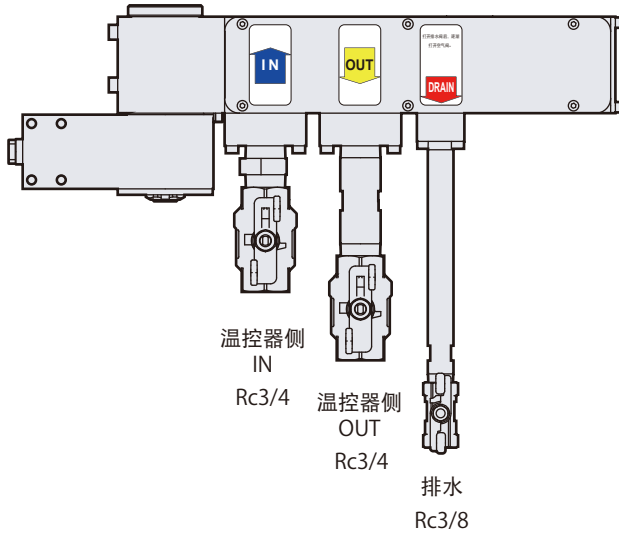

后视图

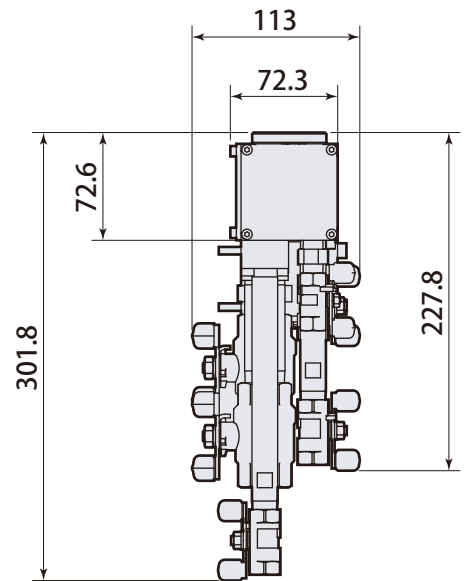
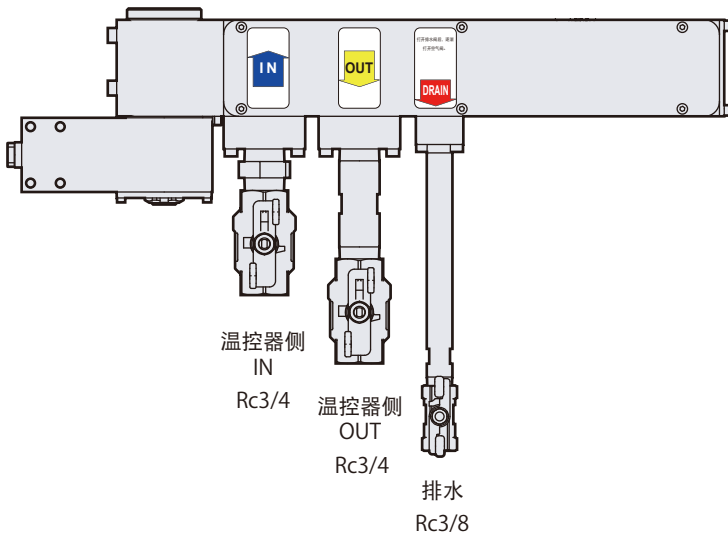

New 阀座 水平型 model MBA-12RH

3,000 kN 注塑机 固定侧 实施例

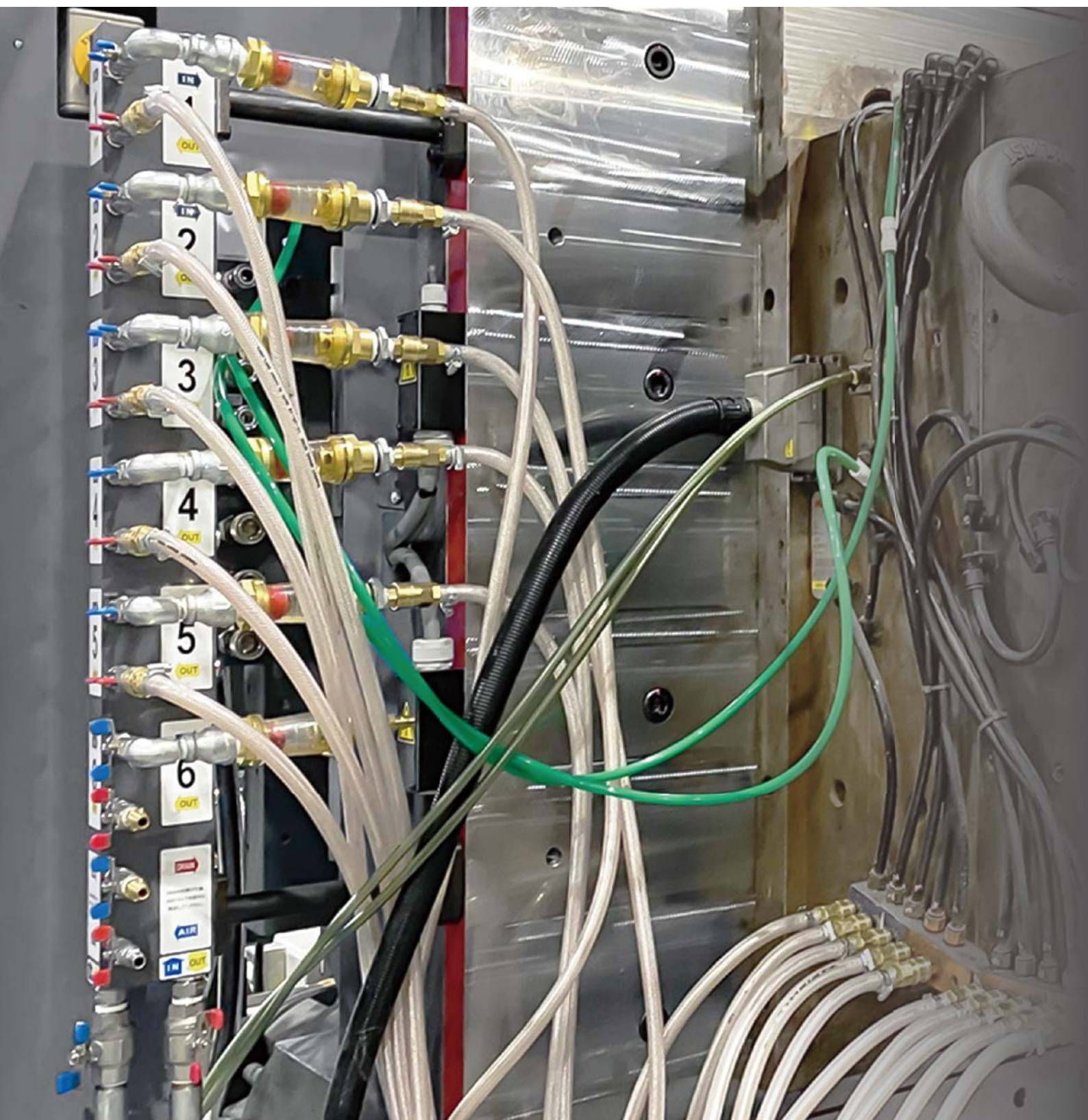

New 阀座 水平型 model MBA-12LH

3,000 kN 注塑机 可动侧 实施例

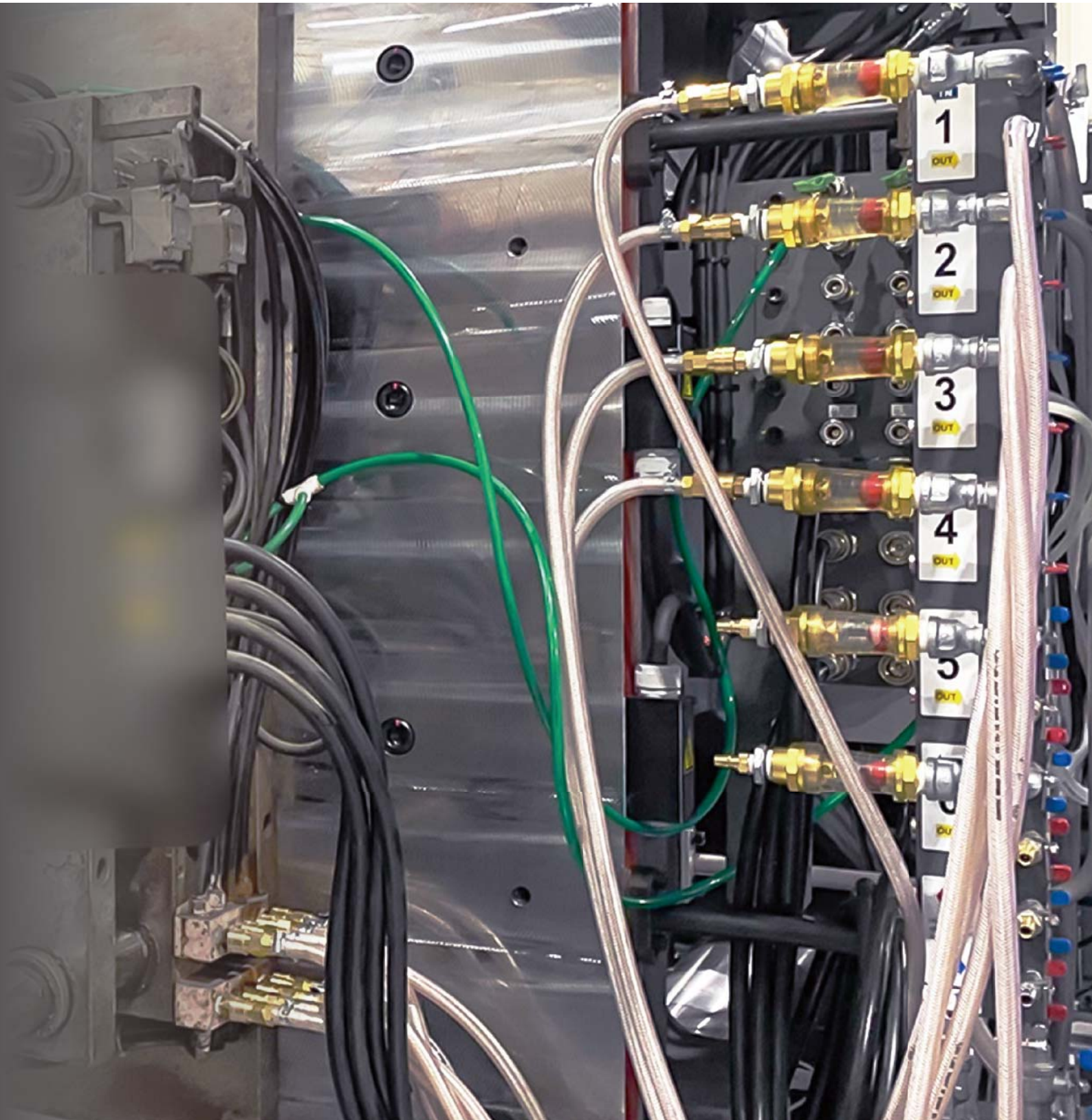

对温控管道进行大胆改革。

- 软管排列整齐防止管道错接
- 提高配管工效
- 多根软管排列工整

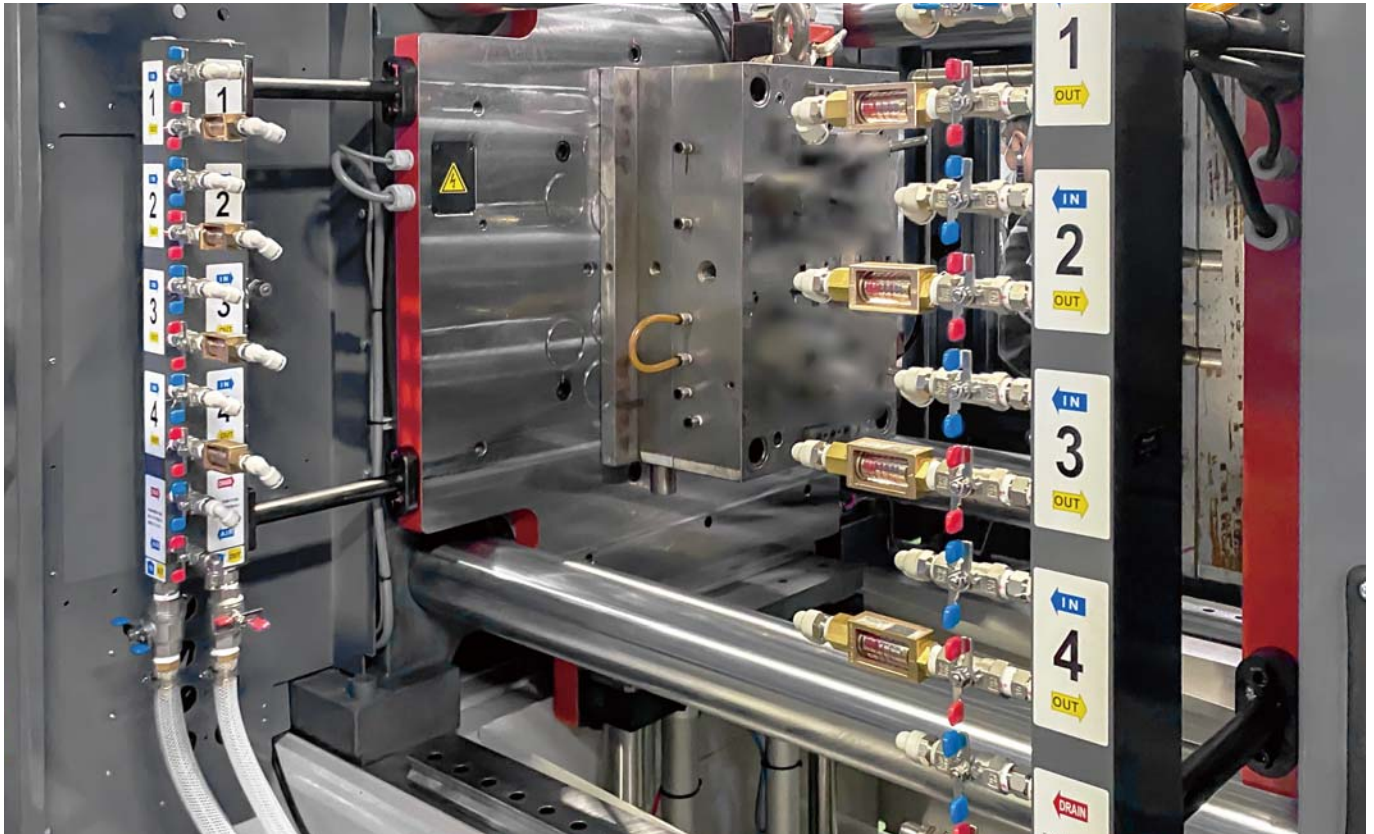

3,500 kN 注塑机 实施例 New阀座 水平型 4回路 8接口 MBA-08RH/MBA-08LH

4回路 8接口
model MBA-08RH

4回路 8接口
model MBA-08LH

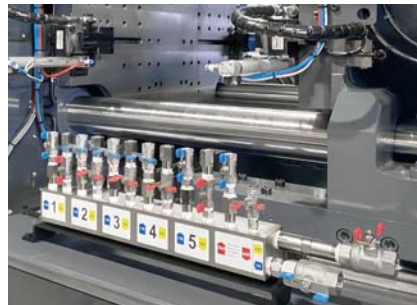
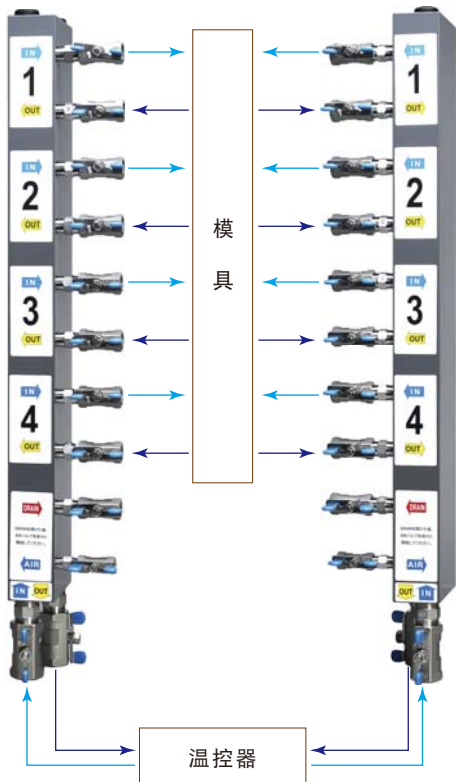

选购品: 水平支架 (→21页)、自立式阀座 (→22页)

规格

适合流体	水、空气、矿物油	
最小通行面积	1次侧接口 314 mm ²	2次侧接口 38.4 mm ²
最高使用压力	1.0 MPa	
最高使用温度	150 °C	
材质	分流管	钢 (化学镀镍)
	球阀	不锈钢

型号表示

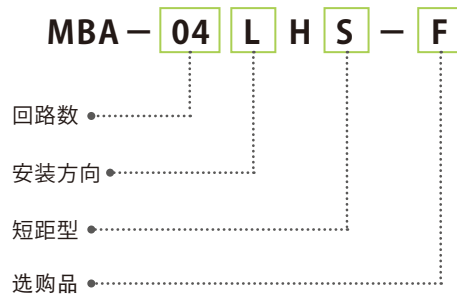

回路数 (接口数)

MBA-04 : 2回路(4接口)
 MBA-08 : 4回路(8接口)
 MBA-12 : 6回路(12接口)
 MBA-16 : 8回路(16接口)

选购品

F : 水平支架
 T : 自立式阀座

安装方向

L : 左侧

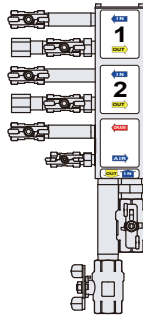

R : 右侧

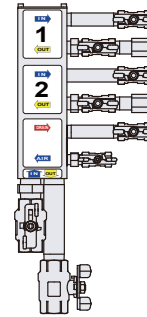

短距型 (总长度较短的紧凑型。)

无符号 : 标准型号

S : 短距型

4回路(8接口)
 model MBA-08RH

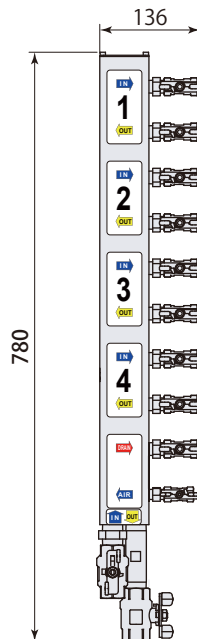

4回路(8接口)
 model MBA-08RHS

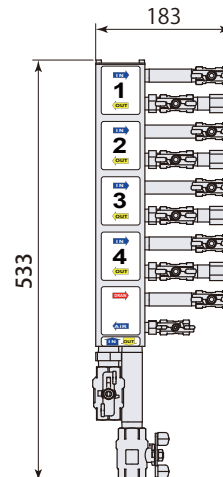

标准型号

2回路(4接口)

model **MBA-04 R** H

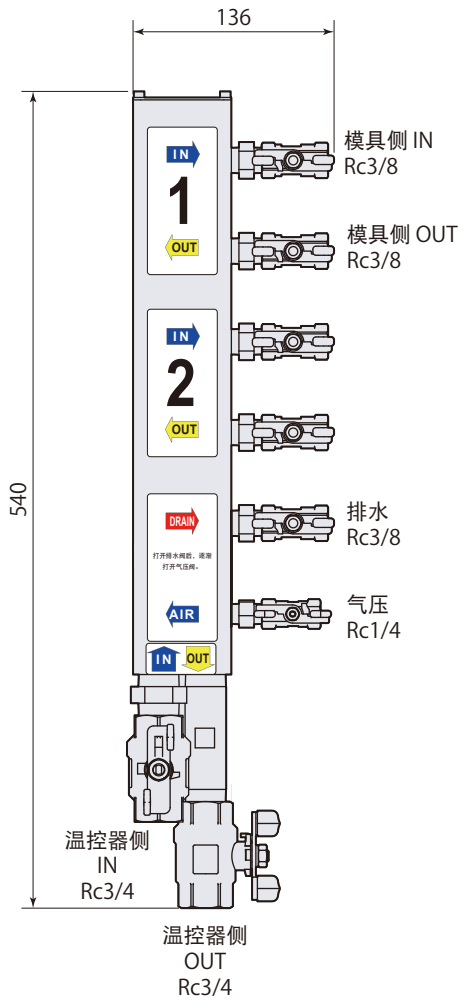

短距型

2回路(4接口)

model **MBA-04 R** HS

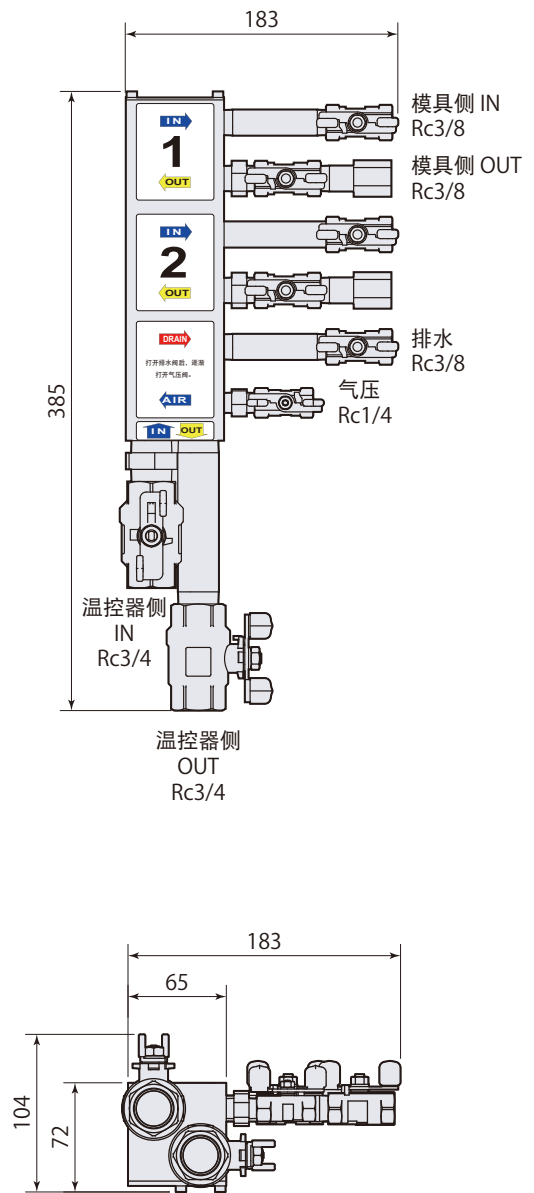

标准型号

4回路(8接口)

model **MBA-08 R** H

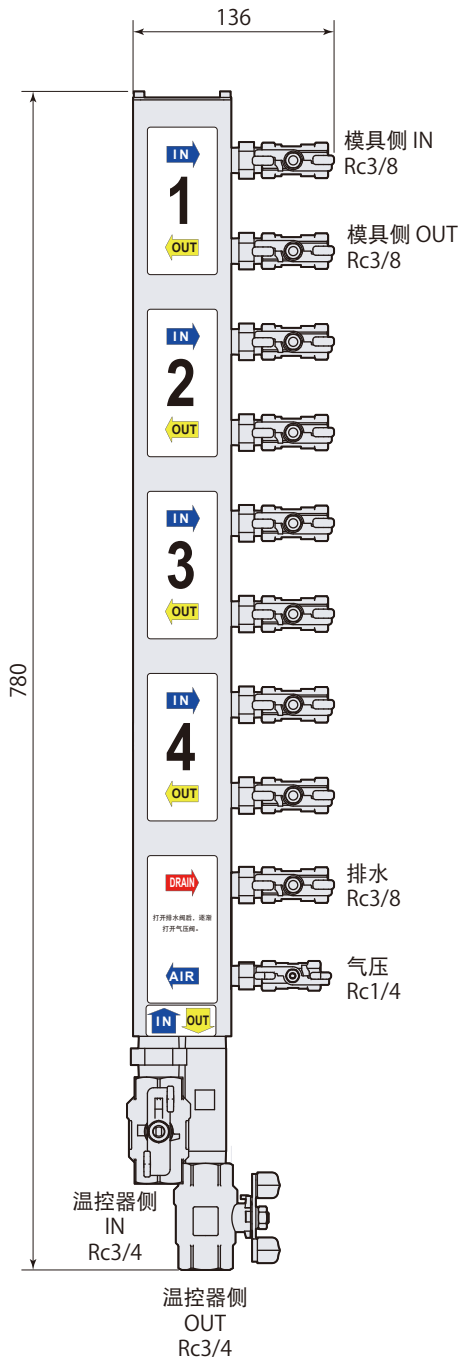

短距型

4回路(8接口)

model **MBA-08 R** HS

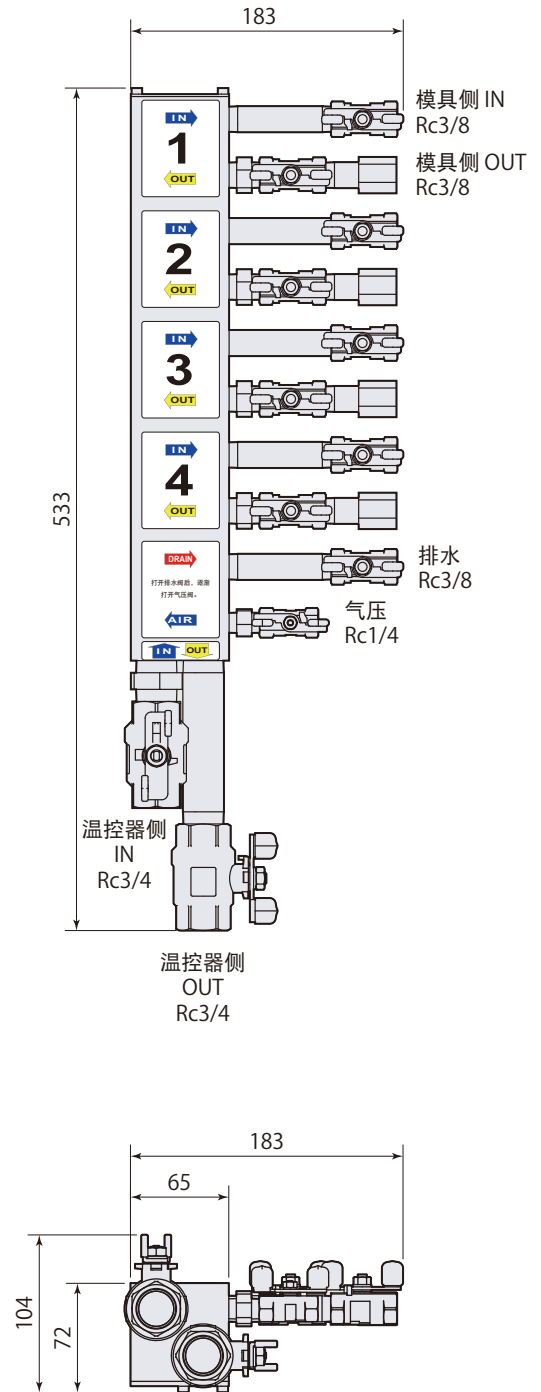

标准型号

6回路(12接口)
model MBA-12RH

短距型

6回路(12接口)
model MBA-12RHS

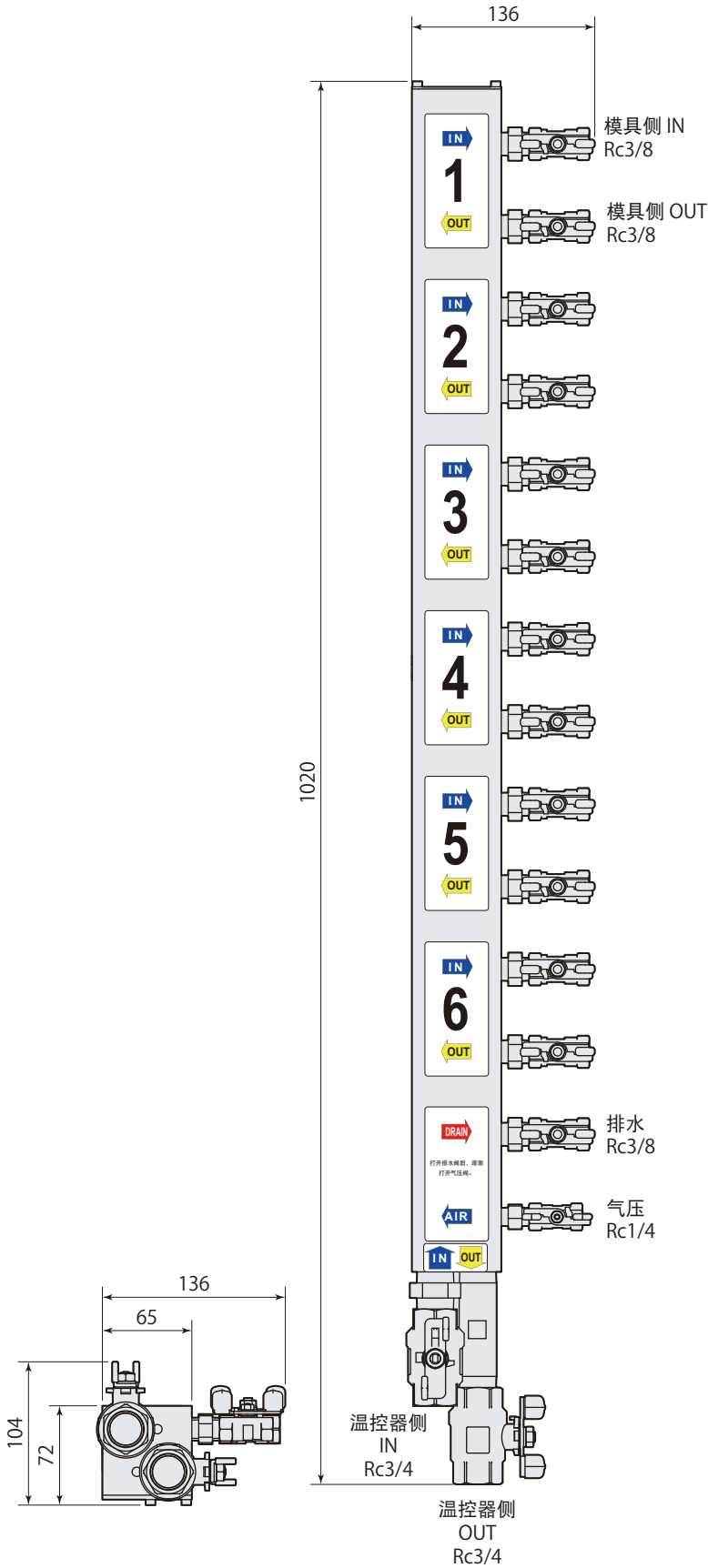

箭头视图A

↑ A

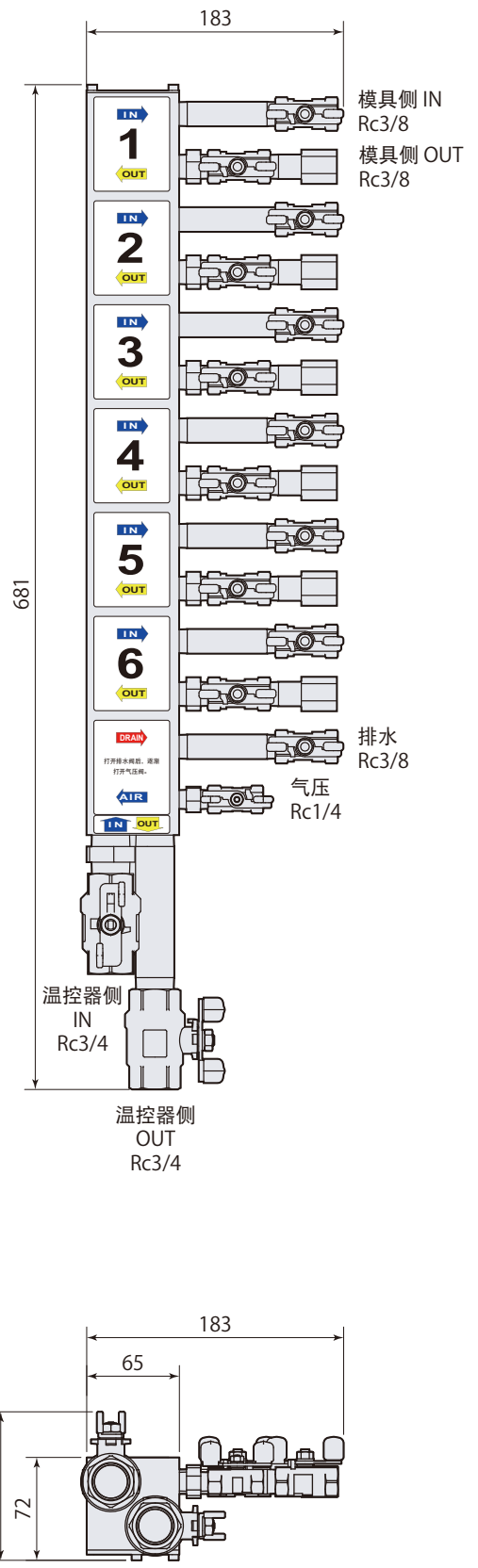

型号表示 R:管道右侧出口 L:管道左侧出口

标准型号

8回路(16接口)
model MBA-16RH

短距型

8回路(16接口)
model MBA-16RHS

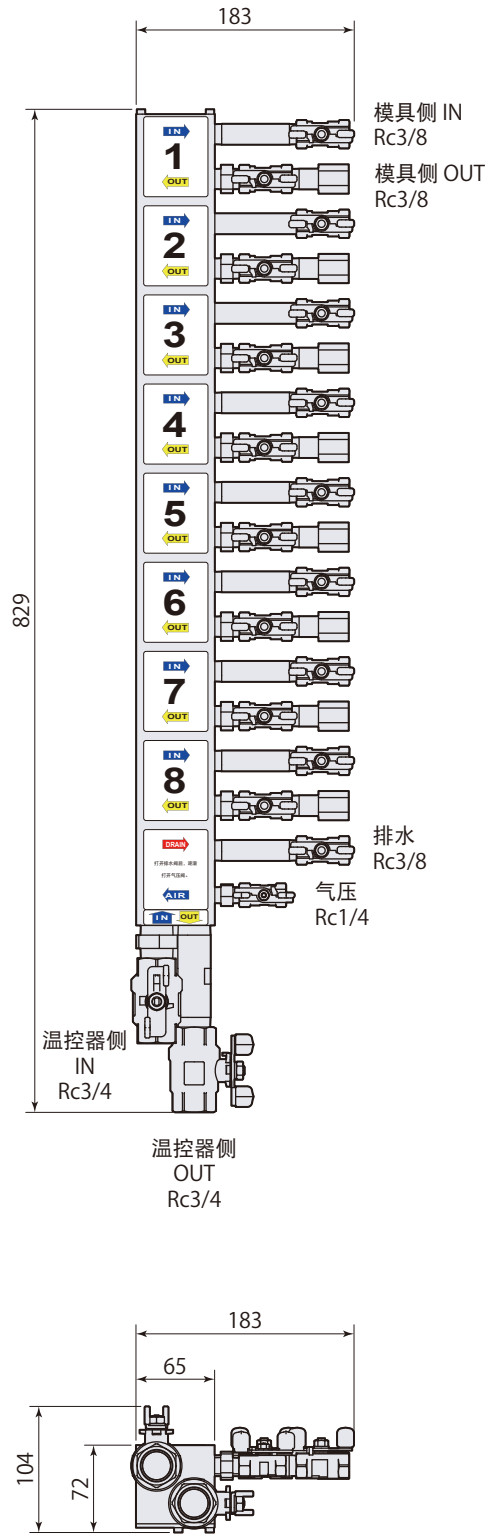
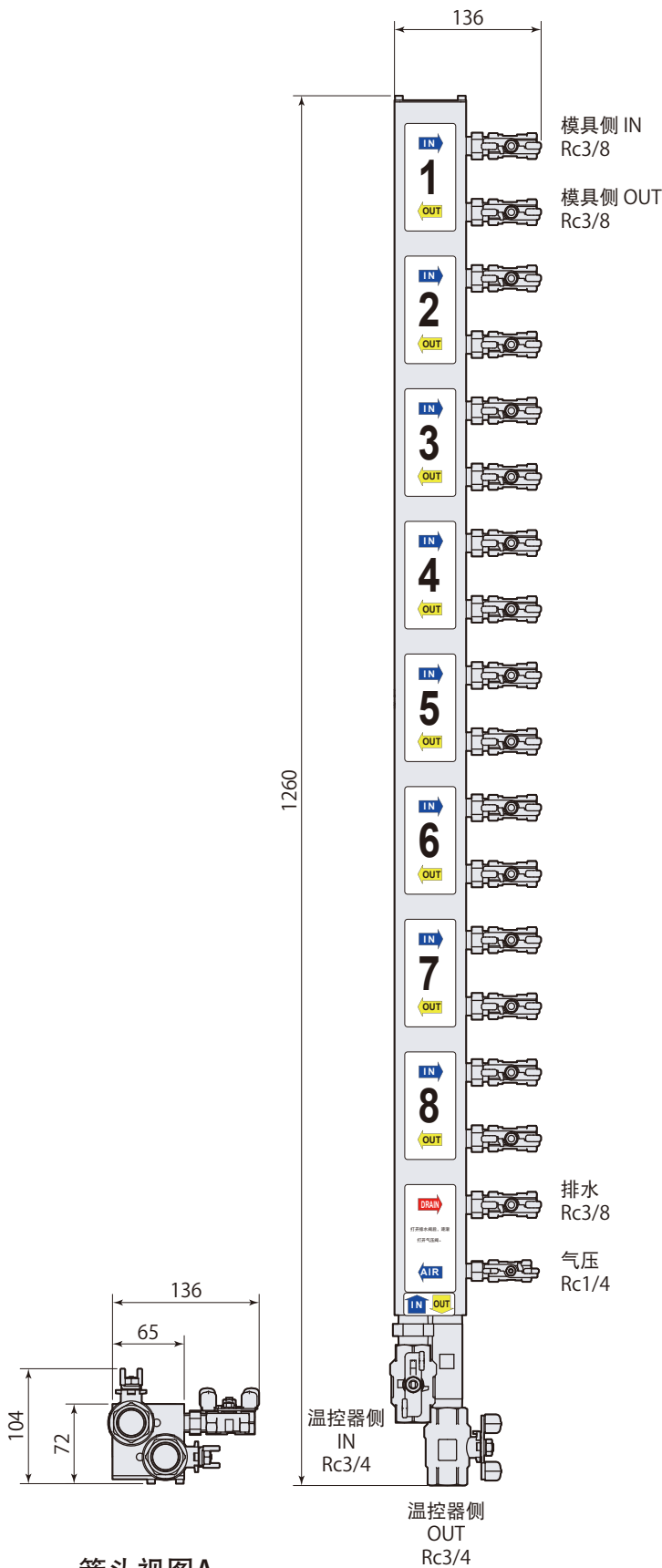

New 阀座 水平型(横向配管) 水平支架

标准型号
2回路(4接口)
model MBA-04RH-F

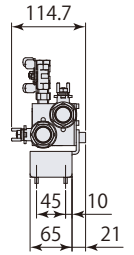
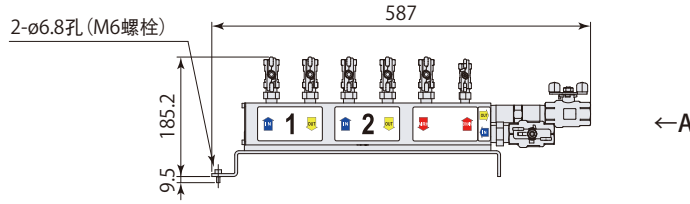

箭头视图A

标准型号
4回路(8接口)
model MBA-08RH-F

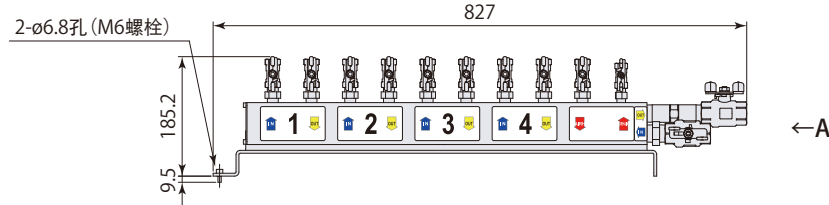

标准型号
6回路(12接口)
model MBA-12RH-F

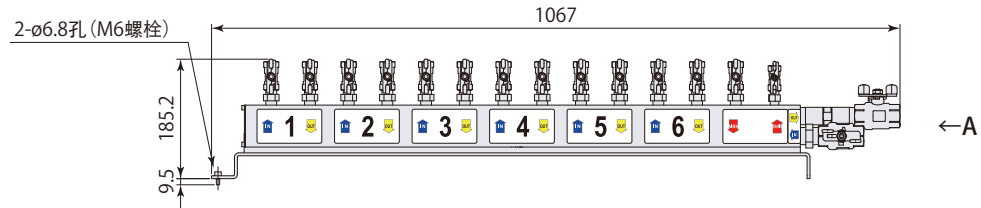

标准型号
8回路(16接口)
model MBA-16RH-F

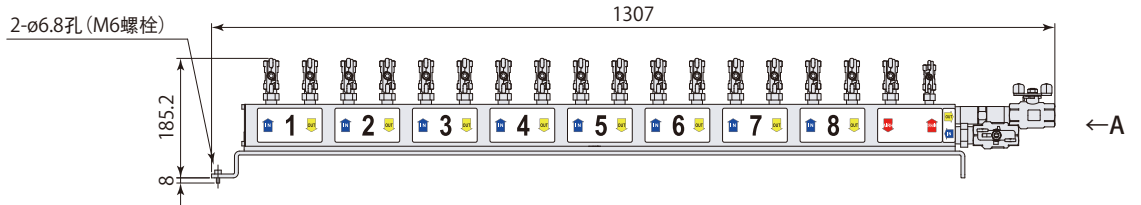

短距型
2回路(4接口)
model MBA-04RHS-F

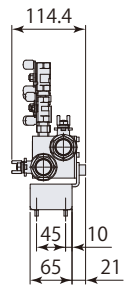
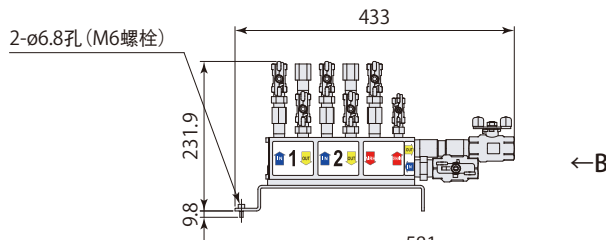

箭头视图B

短距型
4回路(8接口)
model MBA-08RHS-F

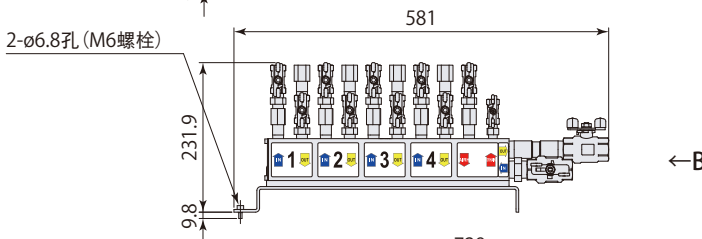

短距型
6回路(12接口)
model MBA-12RHS-F

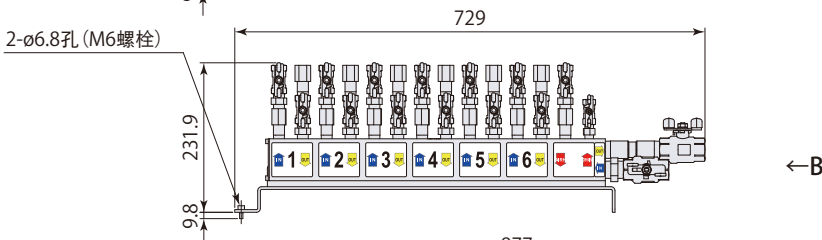

短距型
8回路(16接口)
model MBA-16RHS-F

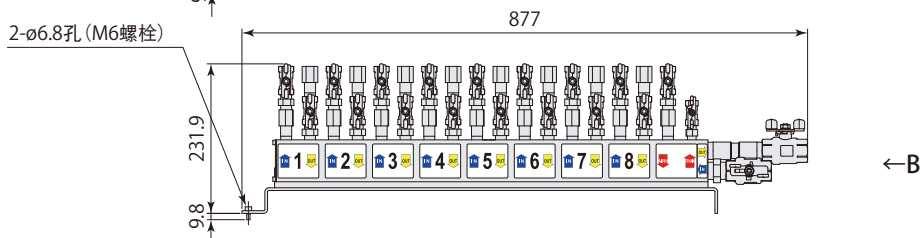

New 阀座 水平型(横向配管) 自立式阀座

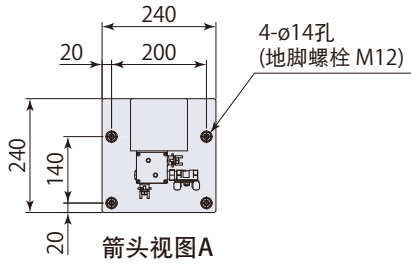

箭头视图A

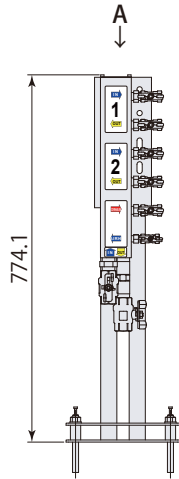

标准型号
2回路(4接口)

model **MBA-04RH-T**

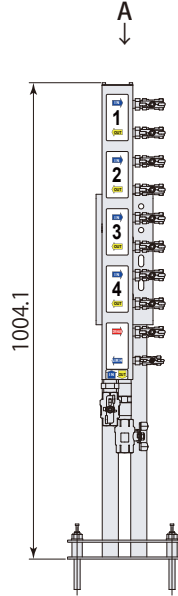

标准型号
4回路(8接口)

model **MBA-08RH-T**

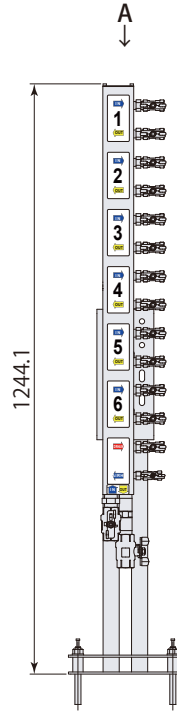

标准型号
6回路(12接口)

model **MBA-12RH-T**

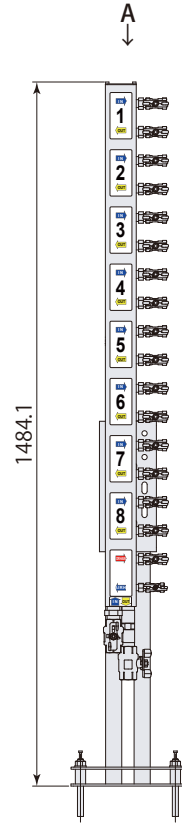

标准型号
8回路(16接口)

model **MBA-16RH-T**

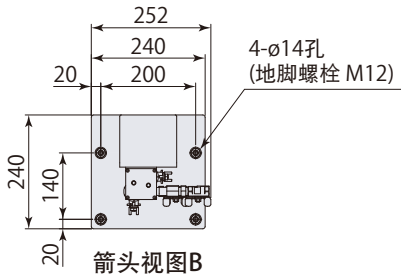

箭头视图B

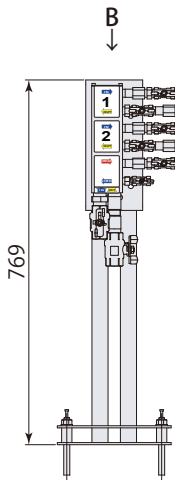

短距型
2回路(4接口)

model **MBA-04RHS-T**

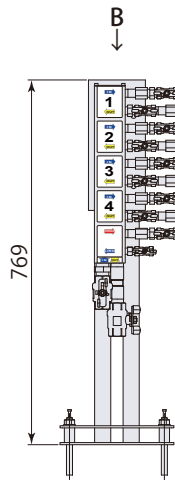

短距型
4回路(8接口)

model **MBA-08RHS-T**

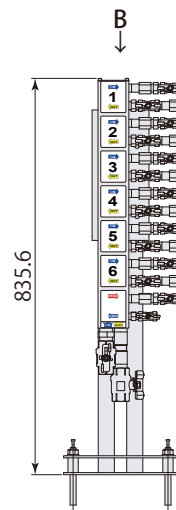

短距型
6回路(12接口)

model **MBA-12RHS-T**

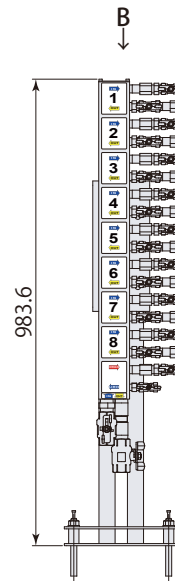

短距型
8回路(16接口)

model **MBA-16RHS-T**

Pascal

大连营业所	帕斯卡(大连)有限公司(Pascal Dalian Corp.) 邮编 116620 辽宁省大连市经济技术开发区双D港二街100-1号1层 电话 0411-8732-2988 传真 0411-8732-7299
上海营业所	帕斯克商贸(上海)有限公司(Pascal Trading Shanghai Corp.) 邮编 201107 上海市闵行区纪翟路1199弄3号1楼 电话 021-5263-4122 传真 021-6296-2882

办事处 ● 长春 ● 天津 ● 武汉 ● 重庆 ● 广州

Pascal corporation Japan

